

# Prospective Process Validation

By

**Dr.A.Anton Smith**

Associate Professor

Department of Pharmacy

Annamalai University.

With

M.Pharm (Q.A) I Year Students (2019-20)

# Contents

1. Introduction
2. Terms and definition
3. History of validation
4. Need for validation
5. Importance of validation
6. Reason for validation
7. Validation protocol
8. Master documentation
9. Product development
10. Development manufacturing capability
11. Full scale product/process development
12. Conclusion
13. References

# 1.Introduction:

- Validation is an essential procedure that demonstrates that a manufacturing process operating under defined standard conditions is capable of consistently producing a product that meets the established product specification.
- In its proposed guidelines by U.S. FOOD AND DRUG ADMINISTRATION(FDA).
- Process validation is establishing documented evidence that provides a high degree of assurance that specific process (such as the manufacture of pharmaceutical dosage form).
- Many individuals tend to think of validation as a stand alone item at end of the entire product\process development sequence.
- Process can be validated first 2 or 3 batches of product satisfy specification.

## 2. Terms and definition

### AS PER WHO:

- Validation means providing documented evidence that any procedure , process, activity or system leads to the expected results.

### AS PER ICH:

- Validation of analytical method is the process by which it is established by laboratory studies ,which the performance characteristics of the method meet the requirements for predetermined standard.

### AS PER FDA :

- Validation is establishing documented evidence , which provide high degree of assurance that a specific process will produce a product meeting its predetermined specification and quality attributes.

# 3. History of Validation

- The concept of validation was first proposed by two FDA officials ,*TED BYERS and BUD LOFTUS*, in the mid 1970's in order to improve the quality of pharmaceuticals
- It was proposed in direct response to several problems in the sterility of large volume parenteral market.

## 4.NEED FOR VALIDATION

1. Basic requirement for the product quality system.
2. Assures that every lot of each product that is released to the market will consistently meet all the quality requirements.
3. Capable of achieving the intended results.

## 6.Reason for validation

- Customer satisfaction
- Product liability
- Reduced product cost
- Support improvements
- Regulatory requirements

# 7.Validation protocols

➤ Validation protocol contain two section:

1. Procedure
2. Form

➤ Specific protocols (SOPs)that provide detailed information



# 8. Master documentation

- As effective prospective validation program must be supported by documentation extending from product initiation to full-scale production.
- The complete documentation package can be referred to as the master documentation file .
- The complete master documentation file not only provides appropriate rationale for the product ,process and, testing.
- It will accumulate as a product concept progresses to the point of being placed in full scale production.
- The final package will be the work of many individual groups within the organization.
- It will consist of reports ,procedures, protocols ,specification, analytical methods, and analytical method development.

# 9. Product development

- Product development usually begins with an active chemical entity has been shown to possess the necessary attributes for a commercial product.
- Generally, product development activities can be subdivided into two categories:
- A. Formulation development
- B. Process development

## A. Formulation development

Formulation development provides the basic information on the active chemical, the formula, and the impact of raw materials or excipients on the product...

# Product development...

## Activities:

1. **Preformulation profile** or characterization of the components of the formula, Which includes all the basic physical or chemical information about the active pharmaceutical ingredients(API or chemical entity )and excipients.

2. **Formulation profile**, which consist of physical and chemical characteristics required for the products , drug –excipients ,compatibility studies and the effect of formulation on in vitro dissolution.

Effect of formulation variables on the bioavailability of the product.

4. Specific test methods

5. Key product attributes and or specifications

6. Optimum formulation

7. Development of cleaning procedures and test methods.

## B. Process development

➤ In this development used for formulation has been developed.

➤ The process development program should meet the following objectives:

1. develop a suitable process to produce a product that meets all

a. product specification

b. Economic specification

c. Current good manufacturing practices (CGMPs)

2. Identify the key process parameters that affect the product attributes...

# Process development...

3. Identify in process specification and test methods

4. Identify generic and or specific equipment that may be required

➤ Process development can be divided into several stages:

1. Design

2. Challenging of critical process parameters

3. Verification of the developed process

➤ A Typical activities in these areas are illustrated in figure following below:

# Product development flow

Process design



Process parameter challenging



Process characterization



Process verification

# 1.Design

- This is the initial planning stage of process development.
- The design of processes should start during or end of the formulation development to define the process to a large extent .
- One aspect of the process development to remember is end user capabilities.
- Process must be developed in such a manner that it can easily be transferred to the manufacturing site with minimal issues.
- The following flow diagram identifies all unit operation, equipment used, and the stages at various raw material are added.

# Typical process flow –granulated product

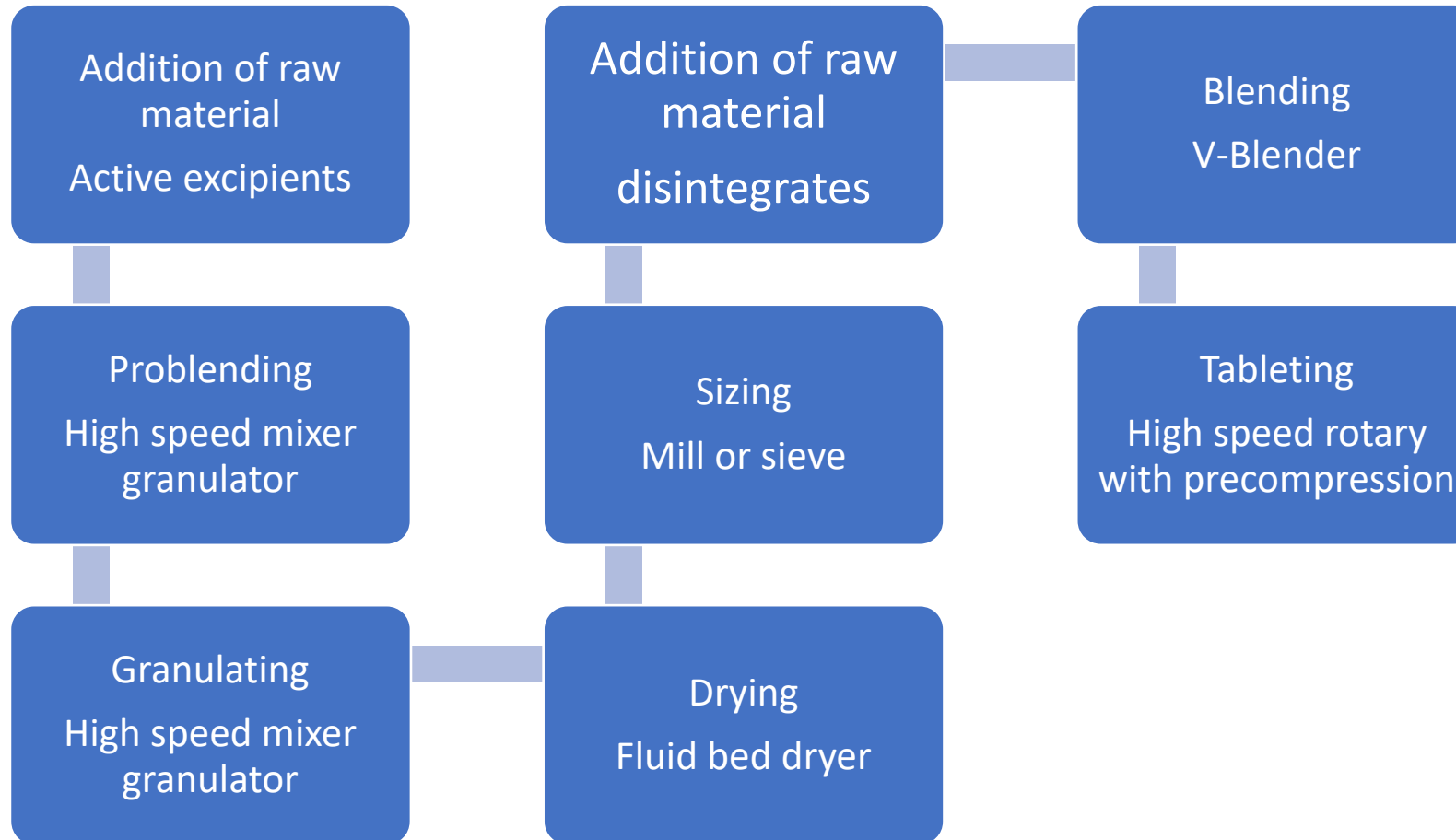



# Typical variable and response: granulated product

| Process step | control variable                    | measured responses   |
|--------------|-------------------------------------|--|
| Problending  | blending time                       | blend uniformity   |
|              | rpm                                 |  |
|              | load size                           |  |
| Granulating  | amount of granulating agent         | density yield  |
|              | initial temperature                 |  |
|              | solvent addition rate               |  |
|              | rpm and granulation time            |  |
| Drying       | drying temperature programme        | density<br>moisture content yield  |
|              | air flow program                    |  |
|              | drying time                         |  |
|              | cooling time                        |  |
| Sizing       | screen type and size                | granule size distribution  |
| blending     | load size, rpm, blending time       | blend uniformity,<br>particle size distribution                              |
| Tableting    | compression rate, granule feed rate | weight variation, hardness ,thickness, dissolution<br>dosage form uniformity |
|              | precompression force                |  |
|              | compression force                   |  |

## 2.Challenging of process parameters

- Challenging of process parameter(also called process ranging)will test whether or not all of the identified process parameters are critical to the product and process being developed.

### These studies determine:

- The feasibility of the designed process
- The critically of the parameters
- This is usually a transition stage between the laboratory and projected final process.

# 3.Characterization of the process

- Process characterization provides a systematic examination of critical variable found during process ranging following objectives:
- Confirm critical process parameters
- Determine their effects on product quality attributes
- Establish process condition for each unit operation
- Determine in-process operating limits
- Confirm the validity of test methods.

# 4.Verification

- Verification is required before a process is scaled up and transferred to production.
- No room for modifying the parameter values and specification.
- Testing during this verification runs will be more frequent and cover more variables than would be typical during routine production.
- Verification stage should be the same or more than the proposed testing for process validation runs.

# 5. Development documentation

- The development documentation to support the validation of the process may contain following:
- Process challenging and characterization reports that contain a full description of the studies performed...
- Development batch record
- Raw material test methods and specification
- Equipment list and qualification and calibration status
- Process flow diagram
- Process variable tolerances
- In process quality control programme
- Critical unit operation
- Final product specification
- Safety evaluation
- Special production facility requirements
- Stability profile of the product
- Produced during process development
- Primary packaging specification.

# 10. Development of manufacturing capability

- There must be a suitable production facility for every manufacturing process that is developed.
- This facility include
  - Building
  - Equipment
  - Staff
  - And supporting function
- In this development depend on the process and the need to utilize or modify existing facilities or establish new ones.

# 11. Full scale product /process development

➤ The development of the final full -scale production process proceeds thorough the following steps:

➤ Process scale –up studies

➤ Qualification trials

➤ Process validation runs

## A.Process scale –up studies

➤ The transition from a successful pilot scale up process or research scale to a full scale process requires careful planning and implementation.

➤ e.g. process characterization and process verification studies...

# Full scale product /process development...

- Many scale –up parameters nonlinear.
- The planning for scale up should follow the same general outline followed for process characterization and verification.
- It is common sense that every effort will be made to conduct the final scale –up studies under CGMP conditions.

## B.QUALIFICATION TRIALS:

- Once the scale –up studies have been completed, it may be necessary to manufacture one or more batches a full scale to confirm the entire manufacturing process, comprising several different unit operation.
- This may occur prior to or regulatory submission.
- This Q.trial depending on the strategy used in filing.



## c.Process validation runs

- After the qualification trial have been completed, the protocol for the full –scale process validation runs can be written.

The validation protocol is usually the joined effort of the following groups:

- Research and development
- Pharmaceutical technology or technical services
- Quality control (quality assurance)
- Manufacturing
- Engineering

## Validation protocol may consist of the following :

- Safety instructions
- Environmental restriction
  - Gas or liquid discharge limitation
  - Solid or scrap disposal instruction
- Equipment
  - Description
  - operation
  - cleaning
- Raw materials
  - Acceptance limits
  - Analytical methods
  - Packaging and storage
  - Handling precautions

# Validation protocol may consist of the following...

- Process flow chart
- Process batch record
- Master batch components(percentage by weight)
- Production batch components (by weight)
- Product testing

## Validation sampling and testing

In-process

Finished product

## Definition of validation criteria

Lower and upper acceptance criteria

Acceptable variation

Cleaning sampling plan(locations ,type, and number of samples).

## d. Master product document

- Some of this document will be directly related to the manufacture of final product
- The documents that are required for manufacturing the product then become the master product document
- Information must be necessary to set up the process to produce the product consistently and one that meets specification in any location
- Items that will normally be included in the master product document are :
  - Batch manufacturing record
  - Master formulation

# Master product document...

- Process flow diagram
- Master manufacturing instruction
- Master packaging instructions
- Specification
- Sampling(location and frequency)
- Test methods
- Process validation data.

# Conclusion:

- Prospective validation of a production process utilizes information generated during the development sequence that produced the final process.
- Validation is supported by all phases of development from the product concept.
- Though validation may seem to be a stand –alone item, it actually is an integral portion of the entire product or process development sequence.

## REFERENCES:

1. Nash R A, Wachter AH (2003) Pharmaceutical Process Validation, (3<sup>rd</sup> edition). Marcel Dekker, Inc, New York, USA.
2. Process validation :general principle and practices-Guidance for industry.
3. <https://WWW.Pharmaguideline.com>>...validation :pharmaceutical guidelines.
4. <https://www.slideshare.net> pharmaceutical process validation.

# QUALIFICATION OF

**LABORATORY EQUIPMENTS:** Pharmaceutical Water System, Pure Steam, Membrane Filtration, Capsule Filling Machine, Hardness Tester, Friability Test Apparatus and Tap Density Tester.

**ANALYTICAL INSTRUMENTS:** UV - Visible Spectrophotometer, HPTLC and LC-Mass Spectrometry, HPLC and GC

By

**Dr.A.Anton Smith**, Associate Professor, Department of Pharmacy, Annamalai University.

With

M.Pharm (Q.A) I Year Students (2019-20)



# Contents

- Objectives
- Introduction
- Validation and system qualification
- Monitoring
- Maintenance
- Revalidation and change control
- Validation documentation

# OBJECTIVES

- ❑ The need for water quality manual
- ❑ Reason for usage of pharmaceutical water supply systems.
- ❑ The technical requirements for water supply systems
- ❑ Different types of water supply system.
- ❑ Validation requirements
- ❑ Qualification & inspection requirement

# INTRODUCTION

- ❑ High quality water is essential for the manufacturing of pharmaceuticals . Water is the most commonly used raw material in pharmaceutical manufacturing .
- ❑ Water is directly or indirectly used in pharmaceutical manufacturing such as a major component in injectable products and in cleaning of manufacturing equipment .
- ❑ It is one of the raw material that is usually processed by the pharmaceutical manufacturer prior to use because it cannot be supplied by the vendor .
- ❑ Water is thus an important raw material in GMP and in validating the manufacturing process .

# INTRODUCTION...

## ❖ **Why purification ?**

- ✓ although tap water is reasonably pure, it is always variable due to seasonal variations, regional variation in quality.
- ✓ One must remove impurities and control microbes to avoid contamination of products .
- ✓ Pre-treatment depends on quality on quality of feed water .

# INTRODUCTION...

✓ Quality of water should be specific for product quality

Water contains,

- Organic and inorganic impurities
- Microbial contamination
- Endotoxin
- Particulate contamination

Low quality of water can lead to

- Product degradation
- Product contamination
- Loss of proof and profit

# TYPES OF WATER

- Different grades of water for pharmaceuticals purposes
- Each type has its own characteristic for all parameters
  - ✓ Portable water
  - ✓ Purified water
  - ✓ Water for injection
  - ✓ Sterile water for injection ,inhalation, irrigation
  - ✓ Sterile bacteriostatic water for injection

# **DIFFERENT TECHNIQUES USED FOR WATER TREATMENT**

- ❖ De-chlorination (sodium bisulphite ,carbon filter )
- ❖ Filtration
- ❖ Ultra filtration
- ❖ Softening
- ❖ Demineralization
- ❖ Reverse osmosis
- ❖ Up treatment
- ❖ Deionization
- ❖ Ozonisation

# **DIFFERENT EQUIPMENTS AND COMPONENTS FOR WATER SYSTEM**

- Piping
- Valves
- Pumps
- Pressure gauges
- Heat exchangers
- Distillation unit
- Filters
- Deionizers
- Sensor
- Auxiliary equipment



# **WATER STORAGE AND DISTRIBUTION – CONSIDERATIONS**

- ❖ Materials of construction (chemical and heat compatibility)
  - Stainless steel (316 or 316L )
  - Teflon ,silicone ,Viton (gaskets ,diameters )
- ❖ Minimize dead legs ( $\leq 2$  pipe diameters)
- ❖ Smooth surfaces (mechanical polish ,electropolish )
- ❖ Clean joints (sanitary tri clamp ,automatic orbital welding )

# **Water storage and distribution ....**

- Design of the following should be appropriate to prevent recontamination after treatment
- Vent filter
- Sanitary overflow
- Tank UV light
- Steam sterilization
- Combination of one –line (TOC ,conductivity meter etc. .)and off –line monitoring (lab testing by proper sampling) to ensure compliance with water specification.

# VALIDATION CONCEPT

- To prove performance of processes or systems under all conditions expected to be encountered during future operations .
- To prove the performance, one must demonstrate (document ) that the processes the specified quantity and quality of water when operated and maintained according to specific written operating and maintenance procedures .

# Validation Concept ...

Validation involutes proving

- Engineering design
- Operating procedures and acceptable ranges for control parameters
- The system must be carefully,
  - Designed
  - Installed
  - Tested during processing, after construction and under all operation conditions .
- Variations in daily ,weekly and annual system usage patterns must be validated .

# WHY VALIDATION OF WATER SYSTEM

- Most widely used and sometimes most expensive ingredient
- Drug component even if not in product
- Generally reviewed in depth by regulators
- Many recalls water related
- Always considered direct impact system
- To ensure reliable ,consistent production of water of required quality
- To operate system within design capacity

# Why validation of water system ...

- To prevent unacceptable microbial ,chemical and physical contamination during production storage and distribution .
- The monitor system performance system performance ,storage and distribution system .

# VALIDATION CYCLE

- It includes four major steps :
  - ✓ Determination of quality attributes
  - ✓ The validation protocol
  - ✓ Steps of validation
  - ✓ Control during routine operation

# **DETERMINATION OF QUALITY ATTRIBUTES**

- The quality attributes, is gaining a clear understanding of the required quality of water and its intended use
- Should be determined before starting the validation
- Without defining required quality attributes ,we cannot establish validation protocols .



# THE VALIDATION PROTOCOL

- A written plan stating how validation will be conducted and defining acceptance criteria for quality .
- For example , the protocol for a manufacturing process

It identifies:

- Process equipment
- Critical process parameters
- Product characteristics
- Sampling
- Test data to be collected
- Number of validation runs
- Acceptable test results

# STEPS OF VALIDATION

- Establishing standards for quality attributes
- Defining system and subsystem
- Designing equipment, control & monitoring technologies .
- Establishing standards for operating parameters
- Developing an IQ stage and OQ stage
- Establishing alert and action levels

# **ALERT AND ACTION LEVELS**

- Alert and action levels are distinct from process parameters and product specifications
- They are used for monitoring and control rather than accept or reject decisions
- The levels should be determined based on the statically analysis of the data obtained by monitoring at the PQ step
- Alert levels are levels or ranges that when exceeded indicate that process may have drifted from its normal operation condition .

# Design qualification of water system

- ❑ Based on the URS supplier designs the equipment This is 1 step in the qualification of new water supply systems
- ❑ Define process schematically by use of PED and P &IDs .
- ❑ It is documented the design of the system & will include :
  - Functional specification (storage purification, etc .)
  - Technical /performance specification for equipment
  - Detailed layout of the system

# INSTALLATION QUALIFICATION

- IQ is in the form of checklist and it should include :
- Instrumentation checked against current engineering drawings and specifications
- Review of P&DID
- Verification of materials of construction
- Installation of equipment with piping
- Calibration of measuring instruments

# **Installation Qualification ....**

- Collection and collation of supplier operating and working instructions and maintenance requirements
- Installation of systems as per design requirements
- Installation verifications
- Systematic range of adjustments ,measurements and test should be carried out to ensure proper installation
- Documentation include details of completed installation

# OPERATION QUALIFICATION

- The purpose of OQ is to establish through documented testing ,that all critical components are capable of operating within established limits and tolerance
- It is the functional testing of system components mainly the critical components
- The purpose of OQ is also to verify and document that the water supply system provides acceptable operational control under ‘at –rest ‘conditions .

# PERFORMANCE QUALIFICATION

- The purpose of PQ is to verify and document that water supply system provides acceptable control under full operational conditions
- PQ should follow successful completion of IQ and OQ
- PO verifies that over time the critical parameters as defined in the DQ are being achieved .

According to the FDA ‘ s advise

- “The observed variability of the equipment between and within runs can be used as a basis for determining the total number of trials selected for the subsequent PQ studies of the process”



# Pure steam validation

## SAMPLING PAN STEAM :

- Sampling for bacterial endotoxin test and chemical test should be done separately.
- Depyrogenated tubes or bottles should be used for taking the sample for bacterial endotoxin test.
- Allow the steam to drain for minimum one minute.
- Open the cap of the bottle and fill the bottle with steam condensate by holding the bottle in the holder .
- Gloves should wear into the hands while sampling the pure steam time

# **Pure steam validation....**

- Gloves should wear into the hands while sampling the pure steam.
- Tighten the cap of the bottle and mark with the sampling information .
- If the sample is not analysed within 2hours of sampling , store the sample at 2-8degree Celsius

# **Analysis of pure steam :**

Pure steam should be analysed for following tests

- Non condensable gases
- Steam dryness value
- pH
- Conductivity
- Microorganisms
- Endotoxin test

# **Non –condensable gases**

- Non condensable gases are air and carbon dioxide those do not condense with the steam .
- These are generated due to their presence in the purified water that continuously circulates in the water distribution system .
- Non condensable gases should not be more than 3.5 %

# Steam dryness value

- Dry steam has more energy than the wet steam .
- Wet steam has water with it and does not have heat energy as dry steam.
- Dryness of steam is determined by the latent heat .
- Dryness of the pure steam should not be less than 90% .
- High moisture content can cause the loss in energy of steam and that may cause a longer sterilization time

# pH

- Steam condensate is analysed for ph. value at 25 degree Celsius
- It should be between 5-7

# **conductivity**

- Conductivity should be tested with calibrated conductivity meter at 20degree Celsius
- Conductivity should not be more than 1.3 cm

# **Microorganisms**

- Steam condensate is tested for microbial contamination using pour plate method
- There should not be any microbial contamination in the steam condensate



# Endotoxin test

- Determine the endotoxin in the pure steam condensate and it should not be more than 0.25EU/ml as in water for injection.

# Validation of purified steam systems

- Clean steam usage in pharmaceutical production clean steam requirements
- Steam –in place –tanks , transfer lines, bioreactors etc.
- Sterilization process –autoclaves
- Clean steam validation requirements
- URS
- DQ
- IQ, OQ & PQ

# REFERENCE

- ❖ Pharmaceutical validation by chitlange
- ❖ [www.pharmaguidelines.com](http://www.pharmaguidelines.com)

# QUALIFICATION OF MANUFACTURING EQUIPMENT MEMBRANE FILTRATION AND CAPSULE FILLING MACHINE

# VALIDATION vs QUALIFICATION

## ➤ VALIDATION:

- Action of providing and documenting that any process, procedure or method actually and consistently leads to the expected results.

## ➤ QUALIFICATION:

- Action of providing and documenting that any premises, system and equipment are properly installed, and/or work correctly and lead to the expected results.
- The term qualification is normally used for equipment, utilities and system, and validation for processes in this sense, qualification is part of validation.

# QUALIFICATION OF MEMBRANE FILTRATION :

## **INTRODUCTION:**

- Unit operation of filtration is the separation of solids from a liquid by passage through a filter medium. Membrane filtration is used for sterilization of drug product and used in sterilization process.
- There are two types of filter used in filtration process: Depth filters: Consist of fibrous or granular materials so packed as to form twisted channels of minute dimensions and they are made of diatomaceous earth, unglazed porcelain filter, sintered glass or asbestos.

# Qualification of membrane filtration...

- Membrane filters: These are porous membrane about 0.1 mm thick, made of cellulose acetate, cellulose nitrate, polycarbonate, and polyvinylidene fluoride, or some other synthetic material.

# EQUIPMENT QUALIFICATION:

## **Membrane filtration:**

- Design qualification
- Operational qualification
- Performance qualification



# Design Qualification (DQ)

- DQ defines the functional and operational specifications of the instrument and details the conscious decisions made in the selection of the supplier.
- DQ should ensure that instruments have all the necessary functions and performance criteria that will enable them to be successfully implemented for the intended application and to meet user requirements.

# Designing qualification ...

The list below shows the recommended steps that should be Considered for inclusion in a Design Qualification:

- Description of the analysis problem
- Description of the intended use for the equipment
- Preliminary selection of the functional and performance specifications (technical, environmental, safety) • Preliminary selection of the supplier
- Final selection of the supplier and equipment
- Development and documentation of final functional and operational specifications

# Operational Qualification (OQ)

- 
- Operational Qualification (OQ) is the process of demonstrating that instrument will function according to its operational specification in the selected environment.
- Before OQ testing is done, one should always consider what the instrument will be used for?
- Testing may be quite extensive if the instrument is to be used for all types of applications and where some of these place great demands on the performance of the system.
- According to a specification appropriate to its routine use. The test frequency is much higher than for OQ. Another difference is that PQ should always be performed under conditions that are similar to routine sample analysis.

# Performance Qualification (PQ)

- Performance Qualification (PQ) is the process of demonstrating that an instrument consistently performs according to a specification appropriate to its routine use.
- PQ should be performed on a daily (or at least a weekly) basis, or whenever the instrument is used.
- The test frequency depends not only on the stability of the equipment but also on everything in the system that may contribute to the analysis results.
  - Define the performance criteria and test procedures.
  - Select critical parameters.
  - Define the test interval

## Validation study element:

- Physical parameter: Sterilization, Integrity test, Operating condition, Shedding, Microbial challenge test.
- Chemical parameter: Inertness, Activity/stability, Test for antimicrobial activities, Consistency and reliability.
- Biological parameter: Endotoxin, Toxicity.

# Sterilization:

- Validation of sterilization method of filter is necessary because filter itself cause contamination of the product.
- To validate use of sterilizing grade filter not only prove that the filter is adequately sterilized but also method does not damage the filter. Most preferred method is moist heat sterilizing.
- Variable like heat up, cool down, pressure, temperature, time, if it is uncontrolled it lead to filter failure.

# Integrity test:

- It should be non-destructive and provide an indication of “fitness for use” This include bubble point pressure test, Retention of bacteria.
- This test of filter should be performed prior to processing and should be performed routinely and conducted after filtration to detect any filter leaks or perforation that might have occurred during the filtration.
- In bubble point test, filter medium wetted with a liquid and test gas pressure is increased until steady stream of bubble appears from tube which is immersed in water. The pressure at which the bubble first appears is recorded as the bubble point pressure.

# Operating condition Time:

- Long processing time could allow bacteria filtered which have been trapped by the filter.
- Filter manufacturer can provide the data on the retention tests that have been conducted for specific membrane and generally suggest that filter should retain bacteria excess of 48hr.
- Filter manufacturer decide the time by performing test. Temperature: Manufacture of filter recommended the limit of 20-25c.
- Pressure: Inlet pressure to the filter must be monitored to ensure that there is no potential for structure damage the differential pressure across the membrane must comply with the filter manufactures recommended limits.



# Shedding:

- It includes particulates and fiber.
- **Particulates:** USP limits when tested by light obscuration method.
- For LVPs not more than 25 particulates per ml  $\geq 10 \mu\text{m}$  and not more than 3 particulates per ml  $\geq 25 \mu\text{m}$ . For SVPs not more than 6000 particulate per container  $\geq 10 \mu\text{m}$  and 600 particulate per container  $\geq 25 \mu\text{m}$ .
- Optical microscopy, light obscuration, light microscopic image analysis, scanning electron microscope are used in particulates count.
- To measure removal of particulates by filter known amount and size distribution of particulates filtered and amount of retention is measured.
- **Fiber:** Fiber releasing filter may not be used in filtration process unless it is not possible to manufacture such drug product without the use of such filters than use subsequently  $0.22 \mu\text{m}$  mean porosity /  $0.45 \mu\text{m}$  membrane filter.

# Microbial challenge test:

- To ensure filter is not undergoing degradation, deformation or some change under condition of use.
- Drug product not causes the organism to shrink resulting in non-sterilizing condition.
- Sterilizing filter one that when challenged with  $10^7$  B.
- Diminution per  $\text{cm}^2$  of filter area will produce sterile effluent. Care should be taken that drug product should not be toxic to organism.

# Filter inertness:

- There may be extraction and adsorption phenomena occur.
- Various techniques for determining inertness like compatibility, pH., conductivity, gravimetric extractable, weight change, adsorption, USP oxidizable substance test etc.
- Stability of the product should not be affected by the filter. In gravimetric extractable test, weight of the extractable are measured when filtered are shocked in ASTM ( American Society for Testing and Materials) grade water for 24 hr.

# A test for antimicrobial activity:

- The test is performed to ensure that, any residual of Antimicrobial Activity is satisfactorily eliminated by using the steps mentioned in this protocol.
- An inoculum of viable cells of the specific bacteria and fungi has been passed through the filter, inoculate filter paper in FTM & incubate at 30 to 35°C or in SCDM and incubate at 20 to 25°C.
- If conspicuous growth does not occur within 3 days for bacteria and 5 days for fungi, the test procedure indicates that the filter has antimicrobial activity.

# Endotoxin:

- Validation must address filter does not add endotoxin to drug product. It depend on quality control process of the filter manufacturer, water used in manufacturing, choice of filter vendor, verification are not done properly.
- Millipak filter unit contain less than 0.5 units of endotoxin per ml as per USP bacterial endotoxin test.

# Toxicity:

- A validation study should determine that passage of the drug product through a filter does not cause any toxicological effects.
- Construction material of filtration system should be non-toxic. Manufacture provide relevant test data such a compendia plastic test similar to USP class 6 test for plastics / USP mouse safety test for all construction materials.
- In USP class 6 test was performed to conform that filter are suitable and non-toxic with contact with parenteral.
- Testing includes systematic and intracutaneous injection as well as intramuscular implantation of filtered into mouse. If no toxicity found then filter passes the test.

# QUALIFICATION OF CAPSULE FILLING MECHINE:

- User requirements specification (URS)
- Design qualification (DQ)
- Installation qualification (IQ)
- Operation qualification (OQ)
- Performance qualification (PQ)

# Types of capsule filling machine

**volume fill**

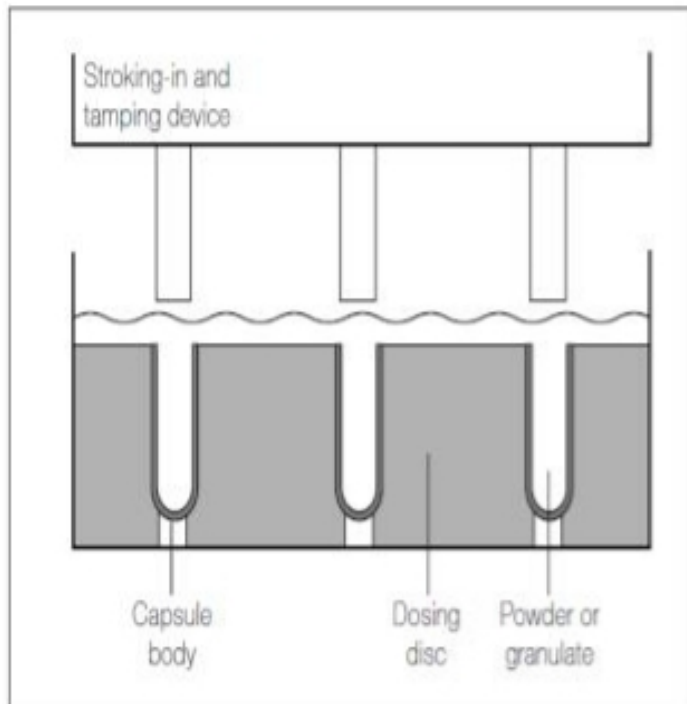

**Agar fill seed system**

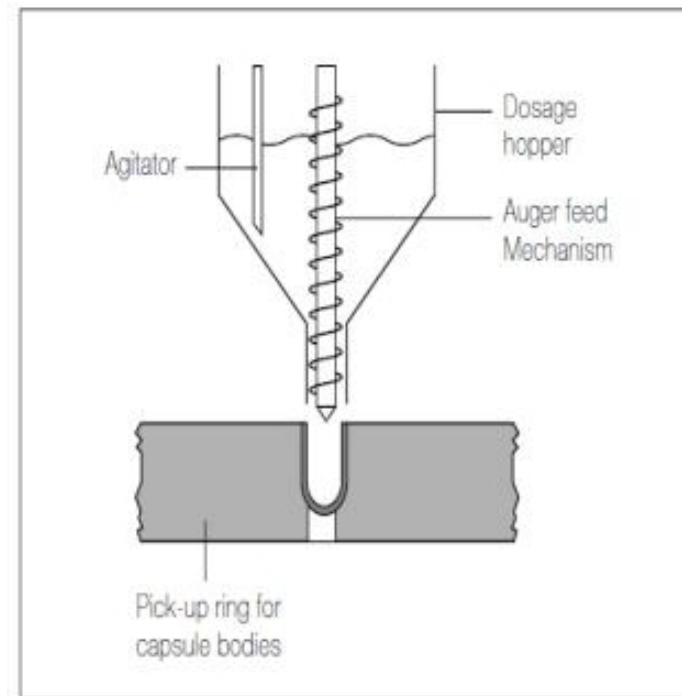



# Types of filling machine ...

## Tamping method

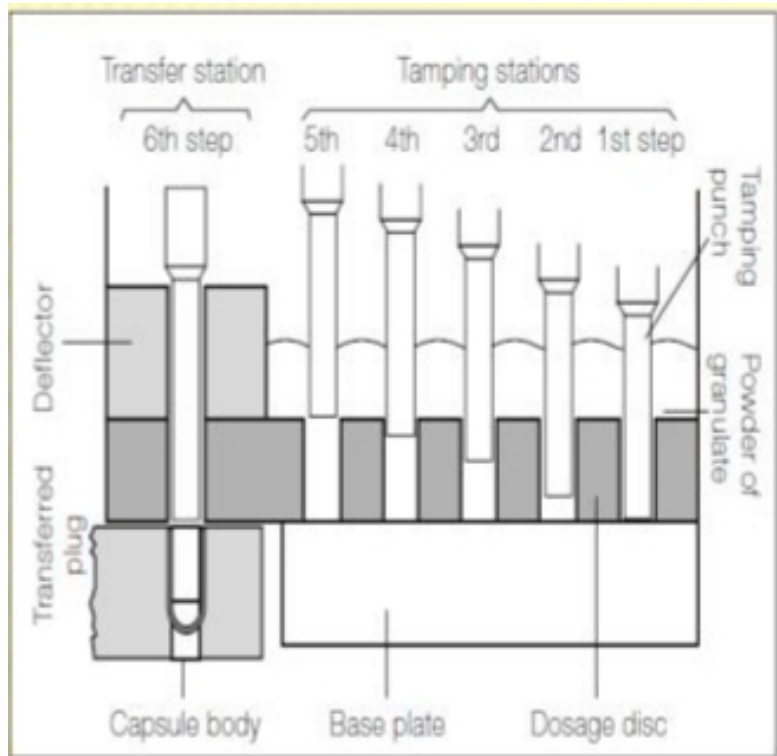

## Compression filling-intermittent

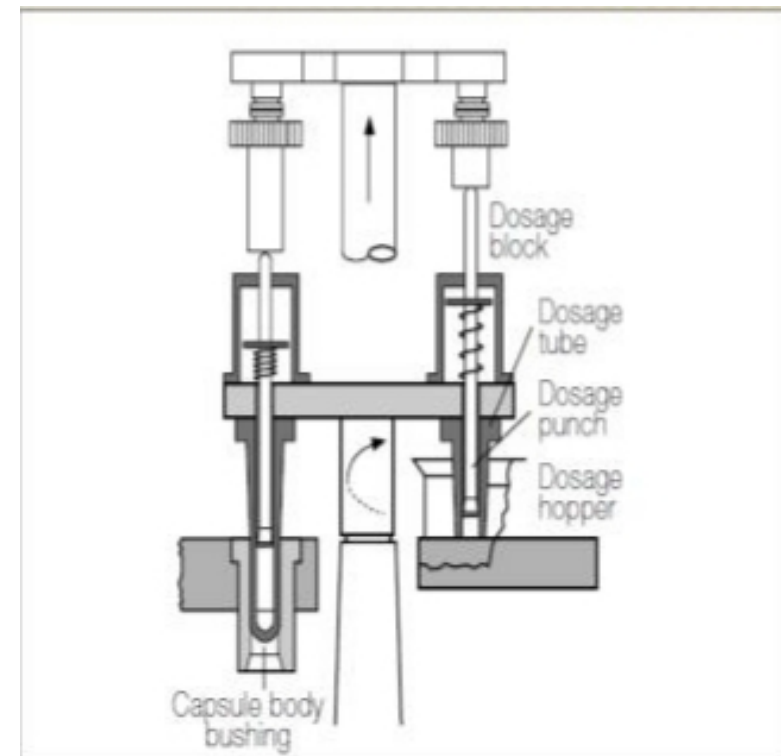

# Type of filling machine ...

## Compression filling- continues

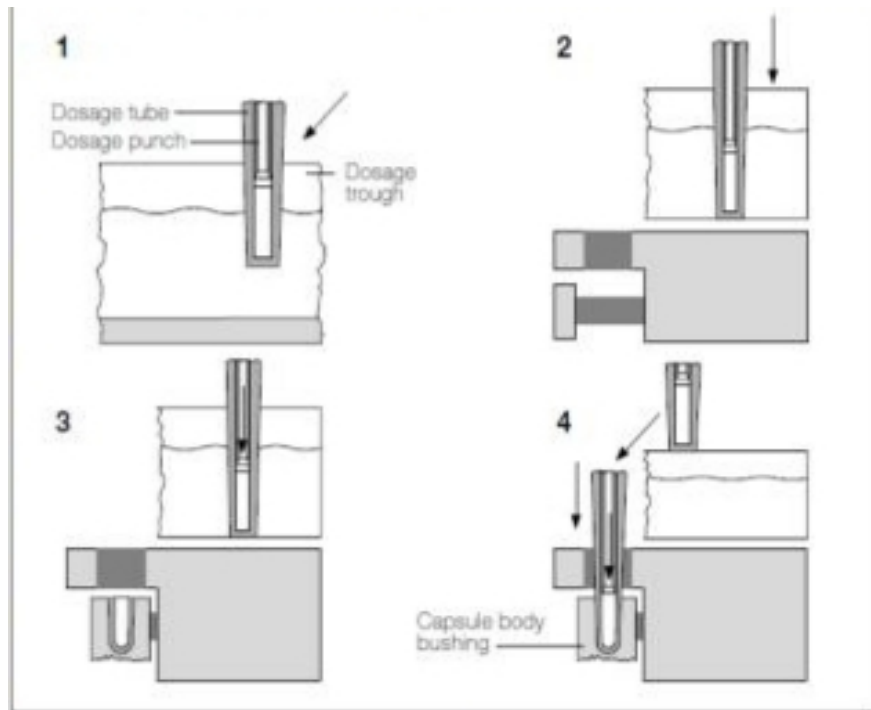
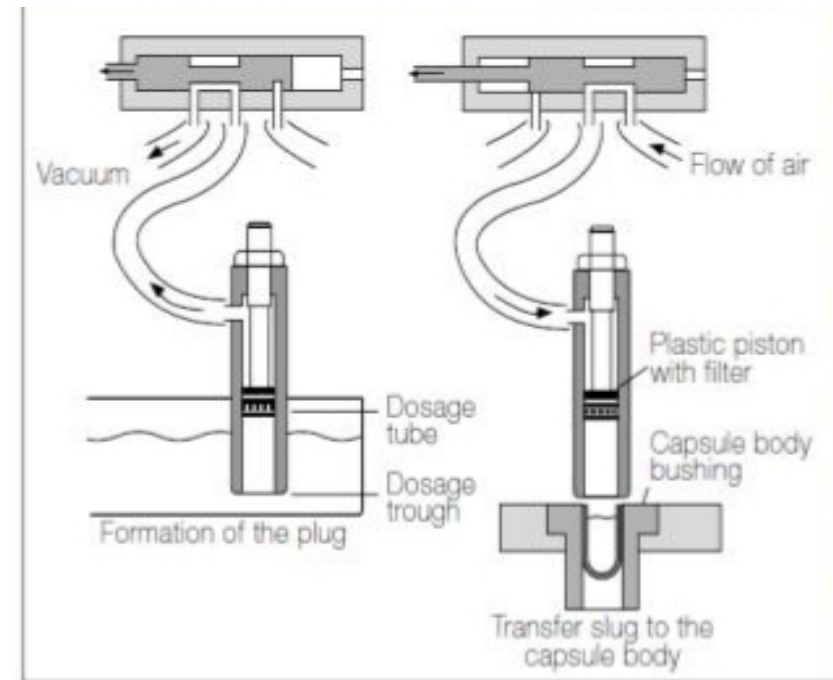

Figure 20. Compression filling - continuous.

## Vacuum filling method



# Types of filling machine...

## Liquid/ semisolid –solid dosage method

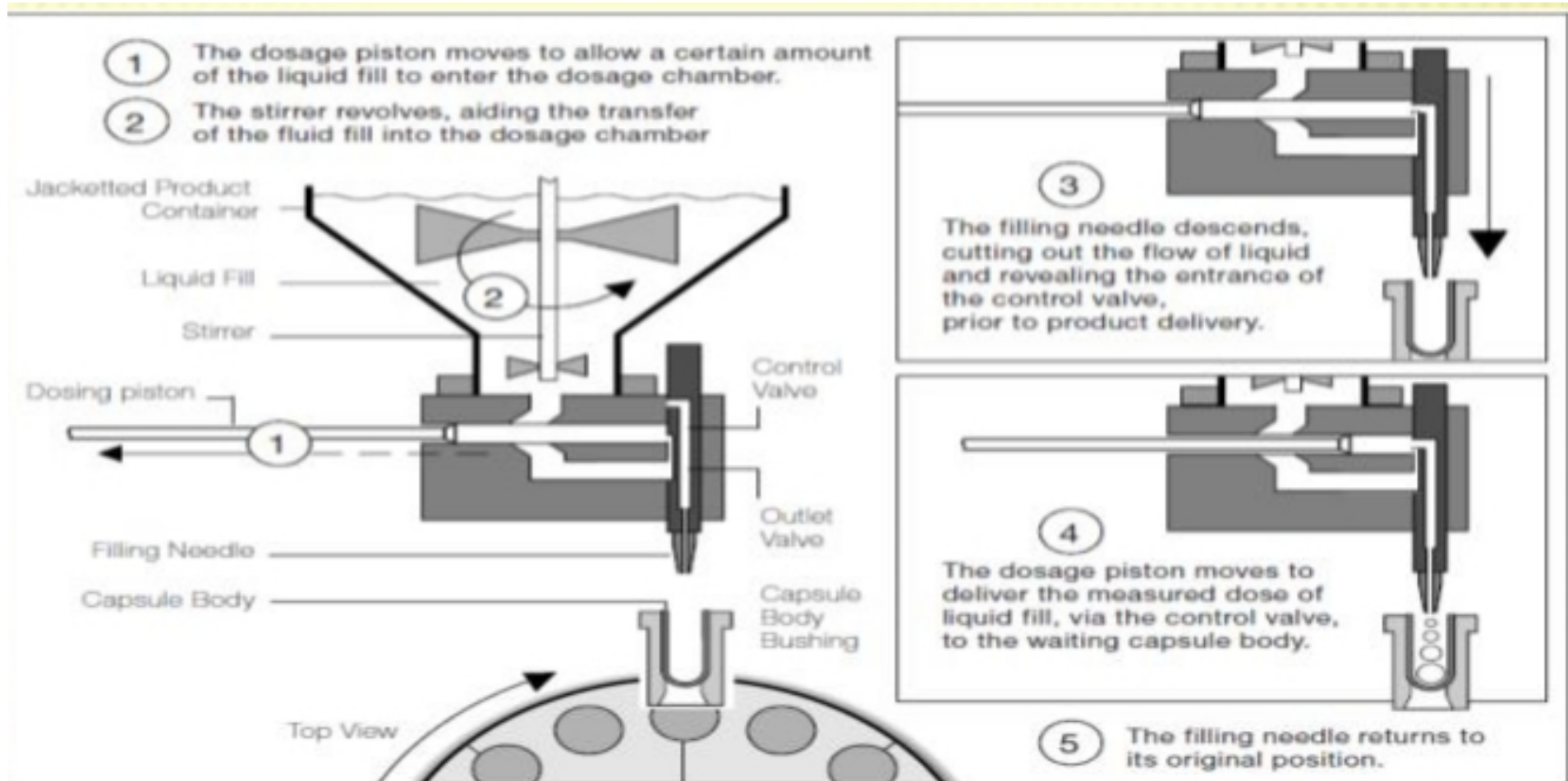

# Types of filling machine ...

## Rotary die encapsulation machine for gelatin capsule

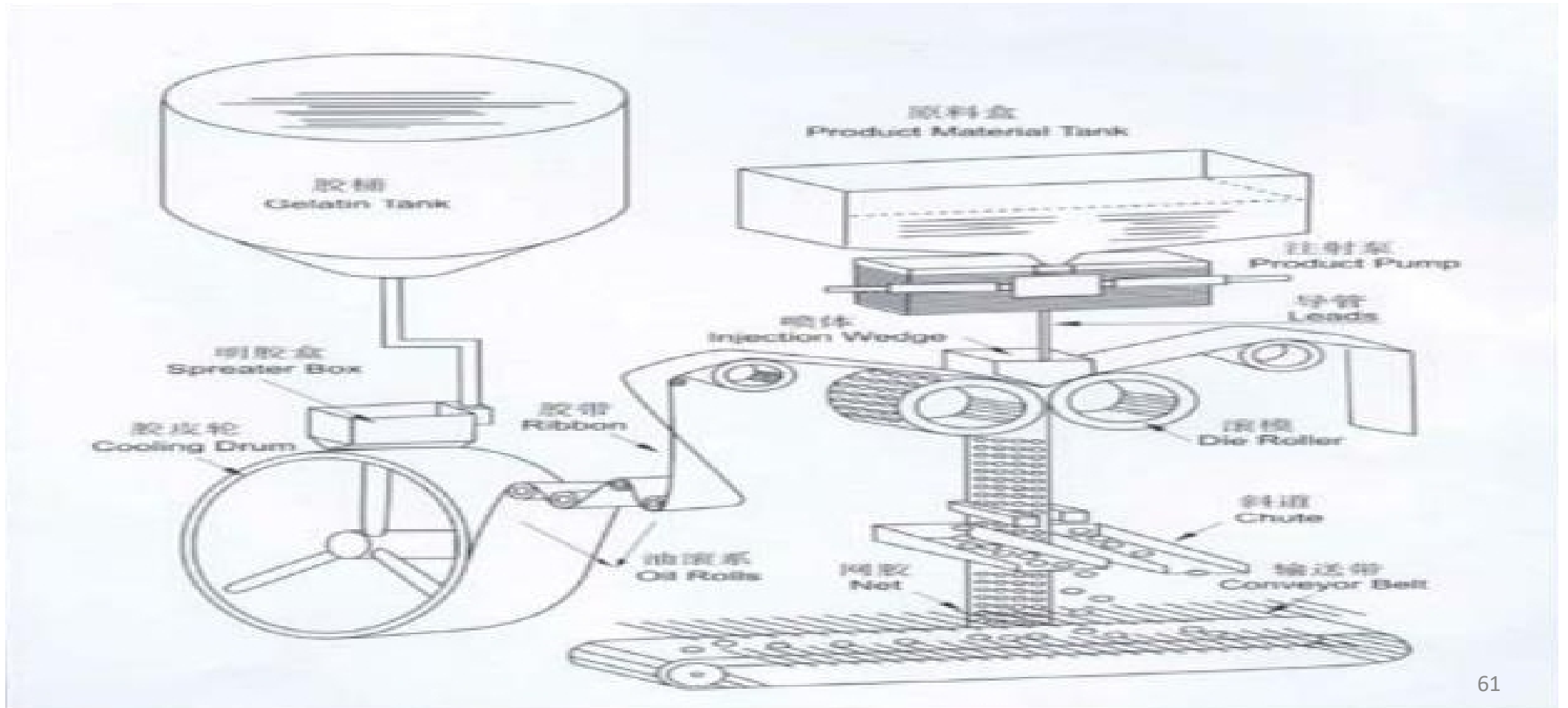

# User requirements specification

- Basic document that is root for all validation and qualification activities
- The goal of working out user requirement specifications is to document the needs of the manufacturing department
- A well prepared URS is the key to project success
- Project without detailed URS have a tendency to demand lots of change later on thus increase cost and start up time
- For evaluation of URS, the coordinated approach among production, QA, engineering units of the pharmaceutical company Is required
- Some companies even use the services of external resources to create a URS

# User requirements specification...

- The key aspects of any URS is to generate a document detailing all the GMP requirements the technical system has to fulfill.
- A detail URS will result in a better and more competitive offer for the technical system.
- Without comprehensive URS, a pharmaceutical company cannot get a clear understanding of supplier and may be led to a wrong decision.

# User requirements specifications...

## Operational requirements of capsule filling equipment

- Operation: Production speed \_\_\_\_\_ capsule per minute
- Capsule will be filled to the target weight  
+/- \_\_\_\_\_%.
- The machine shall not experience more than \_\_\_\_\_% downtime at production speed up to, during an eight-hour production run
- Product contact part: shall be constructed from material acceptable to the product

Certificates for material, weld and finish shall be provided.

Product contact parts are defined

# User requirements specifications...

- Power Failure and Recovery: On power failure, the system shall fall into a “safe state”.  
On power restoration, the system shall not restart without operator or communication-link input
- Emergency-stop: buttons shall be supplied within the reach of the operator at normal operator stations



# User requirements specifications...

## Alarms and Warnings

| Alarm Or Warning               | Immediate* | Operator Alert** |
|--------------------------------|------------|------------------|
| Emergency stop                 | X          |                  |
| Protective guards not in place | X          |                  |
| No capsules                    |            | X                |
| Low product level              |            | X                |
| Control power fault            | X          |                  |

# User requirements specifications...

- **DATA AND SECURITY** : Controls provided with a data collection system intended for use in the manufacture of pharmaceutical products shall comply with 21 CFR, Part 11 of the FDA cGMP regulations.
- Data Collection:
  - Data required for collection
    - Machine rate
    - Alarms and warnings.
    - System status (e.g. “off,” “ on,” “standby” states, etc.)
    - Other (specify)

# User requirements specifications...

## ENVIRONMENT

- Physical condition
- The capsule filler shall be installed in an environment with a temperature range of \_\_\_\_\_ to \_\_\_\_\_ °Fahrenheit and relative humidity range of \_\_\_\_\_ to \_\_\_\_\_ %.
- Vibration levels are:
  - Negligible
  - Other (specify)
- Electromagnetic interference levels are:
  - Negligible
  - Other (specify)

# User requirements specifications...

## ➤ Cleaning

The equipment will be cleaned using the following compounds/cleaning agents/detergents: \_\_\_\_\_ . It is anticipated the equipment will be cleaned on a \_\_\_\_\_ basis.

# INSTALLATION QUALIFICATION (IQ)

The Installation Qualification will confirm details from

- The engineering specifications,
- Equipment purchase order
- cGMP guidelines and requirements,  
verify that the equipment has been installed as specified by the vendor

# Installation qualification...

## ❑ Purchase Details:

- The purchase order no. & date shall be checked
- The accessories & their spare parts if any shall be checked as per purchase order
- The delivery period shall be as per purchase order
- Supplier or manufacturer name & address shall be checked
- Any deviation observed should be informed to the supplier or manufacturer

# Installation qualification...

## ❑ Equipment details

- Equipment name, make & model no. shall be recorded
- In-house identification no. shall be recorded
- Location for installation shall be checked
- Utilities required shall be listed down
- A detailed specification must be written which highlight those parts of machine that are in product contact
- Where stirring devices or augers are used to ensure homogeneity and improve flow then specification of these parts must be checked

# Installation qualification...

## □ **Acceptance Criteria**

- Fulfill the selection criteria & its purpose of Application
- The equipment shall be as per purchase order
- Accessories received shall be as per purchase order
- Should meet pre-selected design parameters
- Manufacturer/supplier shall provide complete equipment manual
- Material of construction shall be as per purchase order



# OPERATIONAL QUALIFICATION

- Before initiating OQ ensure that **SOP** for operation and Cleaning of Capsule Filling Machine is available.

**Purpose:** To train the qualification team for performing OQ

# Operational qualification...

## **Procedure**

- Check all the dynamic attributes of the capsule filler conform to the required specifications
- Initiate the actual operation of the equipment to ensure that machine is operate within the desired rate of output.
- The operation of indicators, controls and alarms is verified
- Oil leaks that could contaminate the process are observed

# Operational qualifications ...

## **Acceptance criteria**

- All operating inputs provided on the equipment when tested shall:
  - successfully comply
  - meet tolerance limit
- The equipment should successfully perform when operated as per SOP
- Critical alarm/indicators provided on the equipment calibrated
- The equipment when operated shall not
  - produce abnormal sounds
  - show any discrepancy in its smooth operation.

# PERFORMANCE QUALIFICATION(PQ)

- PQ activities demonstrates and documents that the equipment is able to perform its intended functions within the variable process limits for a specific product
- Acceptance criteria are developed according to the regulatory requirements and production parameters
- To ensure that the quality and purity of the product is maintained

# Performance qualification....

- The PQ process may also include several challenges to the system challenging the operating limits.
- The PQ's require replicate testing; triplicate testing as the generally accepted minimum.
- The PQ will also test the extremes of the operation, or the peak load conditions, but it does not include testing to failure.

# Performance qualification...

## Procedure

- The accuracy and precision of placebo powder fill will be evaluated for each capsule size that will be used in normal production
- Record the number of damaged capsules
- Capsules from throughout the lot/different batches should be tested for weight uniformity
- Capsules from throughout the lot/different batches should be tested for blend content uniformity
- Production speed i.e capsule per minute should be evaluated

# REFERENCE :

- Venkateswara Reddy B, Rasmitha Reddy B, Navaneetha k, A review on validation of autoclave and membrane filtration, International journal of chemistry and pharmaceutical sciences, 2(2): 642-650, 2014.
- Berry I.R, and Nash R.A, pharmaceutical process validation, second edition, revised and expanded; Marcel Dekker series; 83-110.
- Syed Imataiz Haider, pharmaceutical master validation plan, St. Lucie press, 114,119,120.

# **QUALIFICATION OF HARDNESS TESTER, FRIABILITY TEST APPARATUS AND TAP DENSITY TESTER**



# QUALIFICATION

- ❑ The action of proving and documenting that any premises, systems and equipment are properly installed, and / or work correctly and lead to the expected results.
- ❑ Qualification is often a part (the initial stages ) of validation, but the individual qualification steps alone do not constitute process validation.
- ❑ Qualification is a part of validation.

# CALIBRATION

- ❑ The set of operations that establish, under specified conditions, the relationship between values indicated by an instrument or system for measuring (for example, weight, temperature and pH), recording and controlling, and the corresponding known values of a reference standard.
- ❑ Limits for acceptance of the results of measuring should be established.
- ❑ Always remember that the reference standard is always used in calibration.

# VALIDATION

- ❑ The action of proving and documenting that any process, procedure or method actually and consistently leads to the expected results.
- ❑ It can better understand that the validation is a documented evidence to prove the consistency of the expected results of any process, procedure or method.

# PHASES OF QUALIFICATION

- ❖ Design Qualification
- ❖ Installation Qualification
- ❖ Operational Qualification
- ❖ Performance Qualification
- ❖ Verification Qualification
- ❖ Safety Qualification
- ❖ Maintenance Qualification
- ❖ Re-Qualification

# PHASES OF QUALIFICATION...

## **DESIGN QUALIFICATION**

- The documented verification that the proposed design of the equipment and system is suitable for the intended purpose.

## **INSTALLATION QUALIFICATION**

- The documented verification that the equipment and system as installed or modified, comply with the approved design and the manufactures recommendations.

# PHASES OF QUALIFICATION...

## **OPERATIONAL QUALIFICATION**

- The documented verification that the equipment and system, as installed or modified, perform as intended throughout the anticipated operating ranges.

## **PERFORMANCE QUALIFICATION**

- The documented verification that the equipment and system, as connected together, can perform effectively and reproducibly, based on the approved process method and product specification.

# PHASES OF QUALIFICATION...

## **VERIFICATION QUALIFICATION**

- The documented verification that the equipment and system, as connected together, still in the state of art and actually leads to the expected results and user requirements.

## **SAFETY QUALIFICATION**

- The documented verification that the equipment and system as installed or modified, comply with the safety requirements of process, facility and personnel.

# PHASES OF QUALIFICATION...

## **MAINTENANCE QUALIFICATION**

- The documented verification that the proposed maintenance program of the equipment and system is suitable for the intended purpose.

## **RE-QUALIFICATION**

- The documented verification that the systems, as connected together, are still performing satisfactorily. requalification is required as an outcome of relocation, major modification and due to ageing.



# QUALIFICATIN OF HARDNESS TESTER

# INTRODUCTION



- ❑ Hardness is defined as the resistance of a material to permanent deformation such as indentation ,wear, abrasion, scratch .
- ❑ Principally, the importance of hardness testing has to do with the relationship between hardness and other properties of material.

# INTRODUCTION...

- ❑ For example, both the hardness test and the tensile test measure the resistance of a metal to plastic flow, and results of these tests may closely parallel each other.
- ❑ The hardness test is preferred because it is simple, easy, and relatively non-destructive
- ❑ The necessity for all these different hardness tests is due to the need for categorizing the great range of hardness from soft rubber to hard ceramics.

# NEED FOR CALIBRATION

## **Calibration can be called for**

- With a new instruments
- When a specified time period is elapsed
- When a specified usage (operating hours) has elapsed.
- When an instrument has had a shock or vibration which potentially may have put it out of calibration.
- Sudden change in weather
- Whenever observation appears questionable.

# CALIBRATION OF HARDNESS TESTER

## PROCEDURE

- Take out the force gauge to be calibrated and hold vertically up.
- Adjust the zero on the force gauge.
- Standard weights are then applied to hook of force gauge and measure the tension of the spring on the force gauge.
- When 1kg of standard weight is applied, scale on the force gauge should also show 1 kg tension produced from the initial point where the pointer is adjusted...

# CALIBRATION OF HARDNESS TESTER...

- Adjust the zero on the force gauge again.
- Follow the same procedure for other weights.
- The test to be carried out for 1.0 kg, 2.0 kg, 20.0 kg & 30.0 kg standard weights.

**TOLERANCE:**  $\pm 0.25$  kg /  $\pm 0.1$  kg .

**FREQUENCY:** once in 6 months.

# CALIBRATION OF HARDNESS TESTER...

## MAINTENANCE / REPAIR:

- When the instrument does not comply with the requirement specified above; the instrument should be labelled as “OUT OF CALIBRATION” and should get repaired / serviced.
- After repairing / servicing the instrument before taking for use , the instrument must be calibrated as per the above mentioned procedure.

# GENERAL TYPES OF HARDNESS TESTING

## ❖ 1. MACRO HARDNESS

- In macro hardness refers to testing with applied loads on the indenter of more than 1 kg and covers.

For example, the testing of tools, dies, and sheet material in the heavier gages.( in large scale)

## 2. MICROHARDNESS

- In microhardness testing, applied loads are 1kg and below, and material being tested is very thin (down to 0.00125 mm, 0.0005 inch).



# MACRO HARDNESS TESTING METHODS

- 1. Brinell hardness test**
- 2. Rockwell hardness test**
- 3. Vickers hardness test**

# BRINELL HARDNESS TEST

## INTRODUCTION

- ❑ A Swedish, J. A. Brinell announced Brinell hardness test. He pressed an indicator with a hard ball on the surface of a metal.
- ❑ During testing period, the weights were maintained constant in indicated time.
- ❑ A low order microscope measured the diameters of indentation.
- ❑ The values of diameters will be transferred respectively into the value of Brinell hardness, HB values.

# STANDARD PROCEDURE

- The Brinell hardness test method consists of indenting the test material with a 10 mm diameter hardened steel or carbide ball subjected to a load of 3000kg.
- For softer materials the load can be reduced to 1500 kg or 150 kg to avoid excessive indentation.
- The full load is normally applied for 10 to 15 seconds in the case of iron and steel and for at least 30 seconds in the case of other materials.

# BRINELL HARDNESS TEST...

- The diameter of the impression produced is measured by means of a microscope containing an ocular scale, usually graduated in tenths of a millimetre, permitting estimate to the nearest 0.05 mm.

## BRINELL HARDNESS NUMBER

- The Brinell hardness number, or simply the Brinell number, is obtained by dividing the load used, in kilograms, by the actual surface area of the indentation, in square millimetres.

# BRINELL HARDNESS TEST...

- A well structured Brinell hardness number reveals the test condition.
- “75 HB 10/ 500/30” which means that a Brinell hardness of 75 was obtained using a 10 mm diameter hardness steel with a 500 kilogram load applied for a period of 30 seconds.

# ROCKWELL HARDNESS TEST

## INTRODUCTION

- ❑ S. P. Rockwell announced hardness test in 1919 in the United States; however, it was used to practical by C.H. Wilson.
- ❑ Different weights composed of different material indenters will inspire various usages.
- ❑ There are two kinds of indenters, one is with a steel head and other is with a diamond head.

# TYPES OF ROCKWELL TESTING

## ❖ Rockwell testing:

- In Rockwell testing the minor load is 10 kg and major load (60, 100, or 150 kg) is used regardless of the type of indenter.

## ❖ Rockwell superficial testing:

- In Rockwell superficial testing minor load is 3 kg and major loads (15, 30, or 45 kg ) are used.

# TEST PROCEDURE

- Apply a minor load of 10 kg.
- Then the dial is set to zero and then major load is applied.
- Then apply major load 60 to 150 kg according to the scale used for 4 to 5 seconds.
- Release the major load only.
- All these operation will be done by machine automatically.
- 100 number means most hard and 0 means least hard.



# ROCKWELL TEST PRINCIPLE

□ It consists of measuring the additional depth of heavy load indenter beyond the depth of previously applied light load (minor).

## TYPES OF INDENTERS USED

- ❖ Diamond cone indenters are used for testing hard materials such as hardened steel and cemented carbides.
- ❖ Hardened steel ball indenter are used for testing softer materials such as fully annealed steel, softer grades of cast iron , wide variety of non-ferrous metals and some nanometallic materials.

# ROCKWELL PRINCIPLE

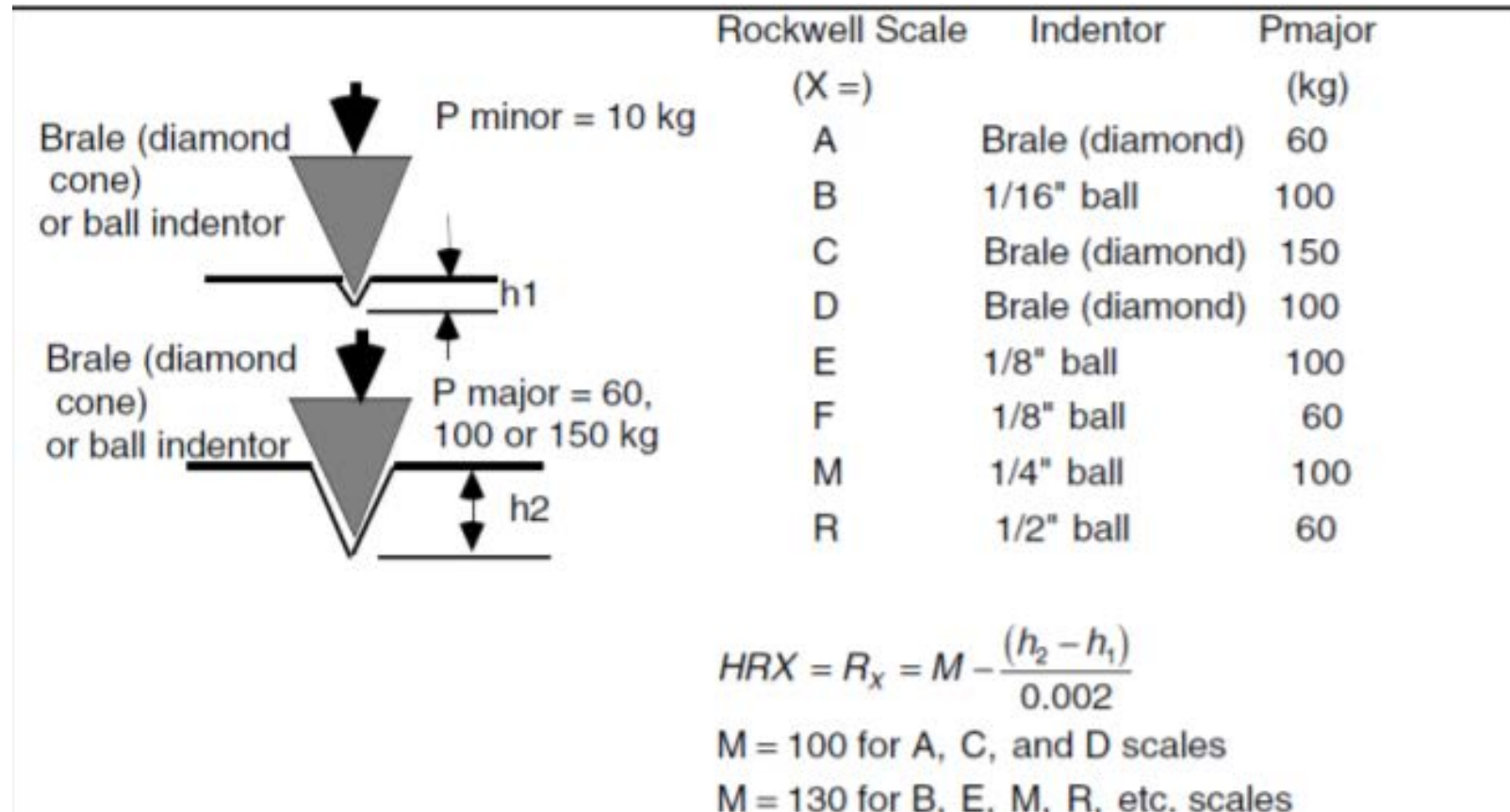

# ADVANTAGES OF ROCKWELL HARDNESS TESTING:

- The most widely used method for determining hardness.
- Simple to perform.
- Highly skilled operations are not required.
- Different types of loads and indenters can be used.
- The entire operation completes within 10 sec.
- Results are displayed digitally on the screen.

# PRECAUTIONS

- During manual operation, the work piece should be raised slowly with the screw as it approaches the indenter.
- The surface being tested must be perpendicular to the direction of the force on the indenter within 2-5 degrees.
- Careless operation in applying load, not only results in inaccurate readings but can damage the indenter.

# VICKERS HARDNESS TEST

## INTRODUCTION

- ❑ The Vickers hardness test was developed in 1921 by Robert L. Smith and George E. Sandland at Vickers Ltd as an alternative to the Brinell method to measure the hardness of materials.
- ❑ The Vickers hardness test method consists of indenting the test material with a diamond indenter, in the form of a right pyramid with a square base and an angle of 136 degrees between opposite faces subjected to a load of 1 to 100 kgf.

# INTRODUCTION...

- ❑ The full load is normally applied for 10 to 15 seconds.
- ❑ The two diagonals of the indication left in the surface of the material after the load are measured using a microscope and their average calculated.
- ❑ The Vickers hardness should be reported like 800 HV/10, which means a Vickers hardness of 800, was obtained using a 10 kg force.

# VICKERS PRINCIPLE

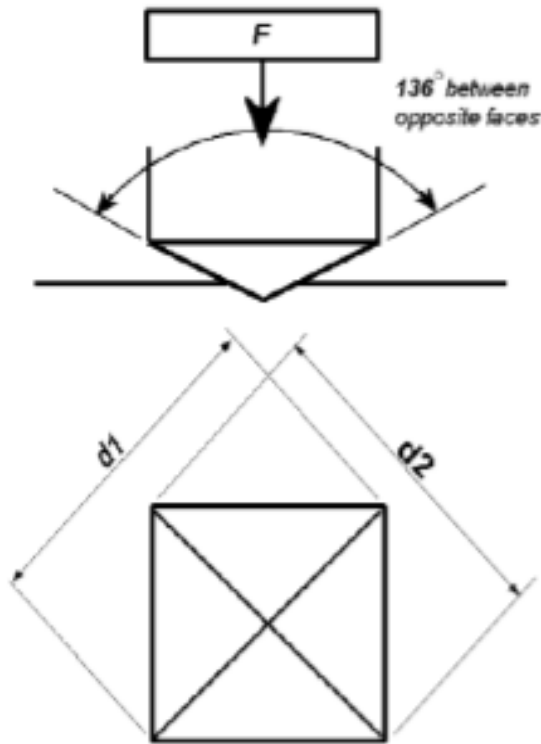

$$HV = \frac{2F \sin \frac{136^\circ}{2}}{d^2} \quad HV = 1.854 \frac{F}{d^2} \text{ approximately}$$

$F$  = Load in kgf

$d$  = Arithmetic mean of the two diagonals,  $d_1$  and  $d_2$  in mm

HV = Vickers hardness

# PROCEDURE

- When specimen is placed in vicker machine and after applying load it produce indentation in the given specimen the load is note from the scale.
- Diagonals lengths of indentation are measured , and angle between the diamond faces .
- From the values known after the vicker hardness test.



# MICRO HARDNESS TESTING METHOD

- ❖ Knoop diamond
- ❖ Vickers diamond pyramid

## KNOOP DIAMOND

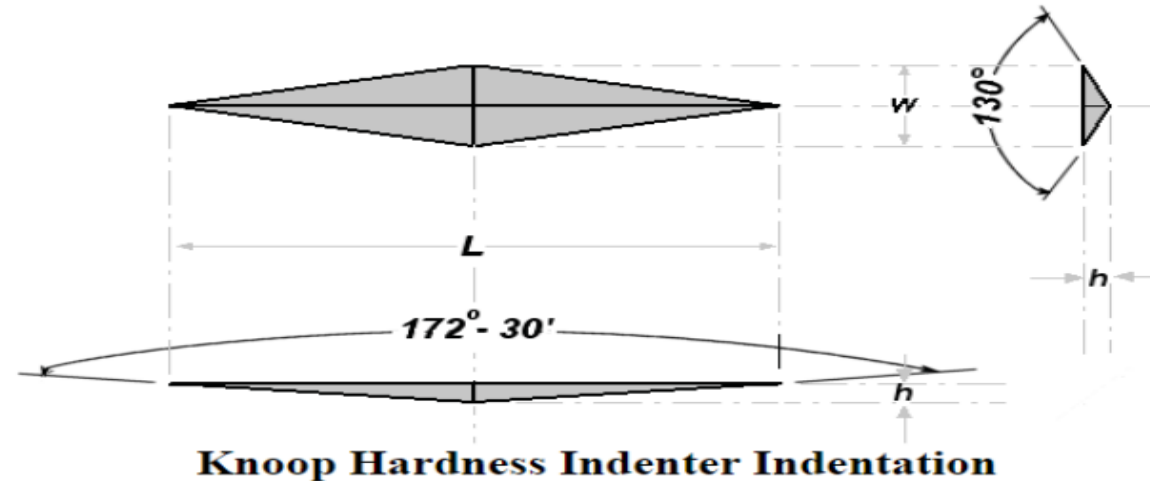

# KNOOP DIAMOND

**KNOOP HARDNESS NUMBER:** is the ratio of the load applied to the indenter. P (kgf) to the unrecovered projected area A (mm<sup>2</sup>).

$$\text{KHN} = F/A = P/CL^2$$

Where ;

- F= applied load kgf L=measured length of long diagonal of indentation in mm.
- C=0.07028=constant of indenter relating projected area of the indentation to the square of the length of the long diagonal.

# VICKERS DIAMOND PYRAMID

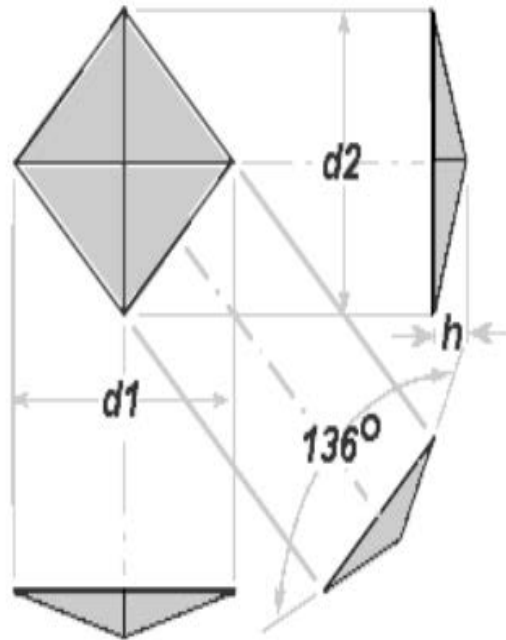

## Vickers Pyramid Diamond Indenter Indentation

$$HV = \frac{2F \sin \frac{136^\circ}{2}}{d^2} \quad HV = 1.854 \frac{F}{d^2} \text{ approximately}$$

$F$  = Load in kgf

$d$  = Arithmetic mean of the two diagonals,  $d_1$  and  $d_2$  in mm

HV = Vickers hardness

# QUALIFICATION OF FRIABILITY TEST APPARATUS

# QUALIFICATION OF FRIABILITY TEST APPARATUS

## **FRIABILITY TEST:**

- Friability is defined as the % of weight loss by tablets due to mechanical action during the test.
- Tablets are weighing before and after testing and friability is expressed as a percentage loss on pre test tablet weight .
- Friability refers the ability of the compressed tablet to avoid fracture and breaking during transport.

# FRIABILITY TEST...

- Friability is closely related to tablet hardness and is designed to evaluate the ability of the tablet to withstand aberration in packing, handling and shipping.
- Friability is usually measured by the use of Roche friabilator or tumbler test .
- A number of tablets (20 no) are weighed and placed in the apparatus where they are exposed to rolling and repeated shocks as they fall 6 inches in each turn within the apparatus.

## FRIABILITY TEST...

- After 4 minutes of this treatment or 100 revolutions the tablets are weighed and the weight compared with initial weight.
- The loss due to abrasion is a measure of tablet friability.
- The value is expressed in percentage.
- Minimum weight loss of the tablet should not be NMT 1 %
- They should not be any broken test.

# FRIABILITY

## FRIABILITY

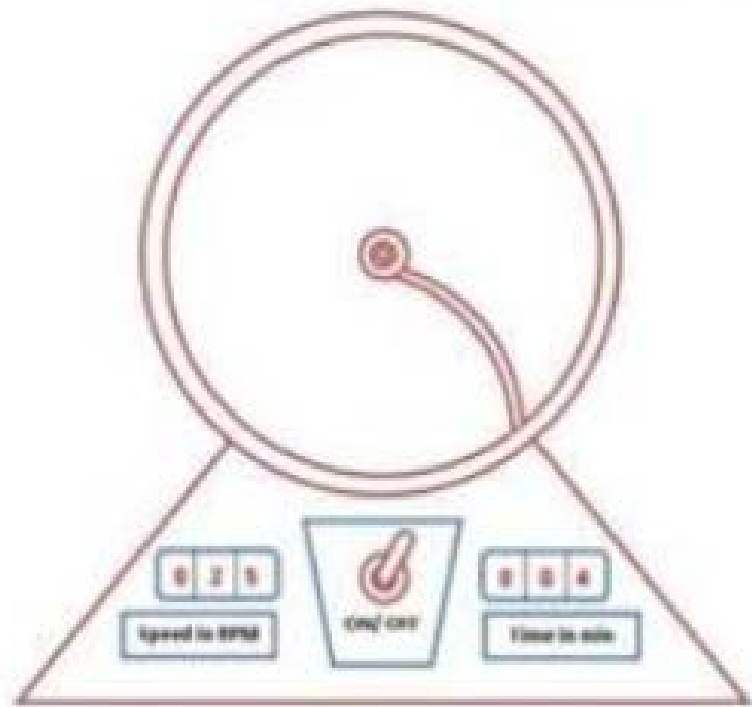

ROCHE FRIABILATOR (2)





# FRIABILITY...

- This testing involves repeatedly dropping a sample of tablets over a fixed time, using a rotating wheel with a baffle.
- The result is inspected for broken tablets and the percentage of tablet mass lost through chipping.
- Applicable for compressed uncoated tablet & intended to determine the strength of tablet during transportation & storage the tablets should retain its shape & size.

# FRIABILITY...

## METHODS:

- Drum diameter : 283-291 mm
- Depth :36-40 mm
- Inner radius of the curve projection: 75.5mm-85.5mm
- Outer diameter of the central ring: 24.5mm-25.5mm
- Rotation speed :  $25 \pm 1$  cycle
- Time set : 4 min.

# CALIBRATION OF FRIABILITY TEST APPARATUS

- Switch ON the power .
- The drum will initialize itself to the loading position at the power ON .
- The display will show “start”.
- After the weighing (A) slide the tablets (for tablets with a unit mass equal to or less than 650 mg, take sample of whole tablets corresponding to 6.5 g.
- For tablets with a unit mass of more than 650 mg, take a sample of whole 10 tablets) gently into the drum from the slide slit provided on the drum...

# Calibration of friability test apparatus ...

- Select the “TIME MODE” or “REVOLUTION COUNT MODE” as desired by pressing the TIME/COUNT/ key respectively.
- The MODE indicator LED will indicate the selected mode.
- The display will show the previous Time or Count Values.
- Enter the desired value (25 rpm, 4 minutes or described under individual monograph) for the selected mode and press ENTER KEY to register the value.
- Press RUN/HALT key to start the test .

# Calibration of friability test apparatus...

- The drum will start rotating.
- The display will show elapsed Time or Count on depending on the mode selected.
- When the test is over, the drum rotates in the reverse direction , discharging the tablets into the tray.
- Take weight after rotation is completed (B).
- Then drum will initialize itself to loading position and display will show “start” indicating that the instrument is ready for the next test.

# Calibration of friability test apparatus...

- In case during the test, if the user needs to change the Time/Count value, press RUN/HALT key.
- Pressing the RUN/HALT key again to continue the test .
- Find out the loss in weight of the tablets(i.e. A-B)
- Calculate the percentage of loss by following formula :

$$(A-B) \times 100 \div A$$

# Calibration of friability test apparatus...

- Find out the percentage loss.
- Make the entry in the usage log book.
- Similarly , operate the instrument and count the revolution for calibration as annexure 1.
- Calibration frequency: monthly and after major maintenance.

# ANNEXURE 1

Annexure-I

| Sr. No. | Parameter | Standard Value            | Observed value |           | Limits    | Remarks |
|---------|-----------|---------------------------|----------------|-----------|-----------|---------|
|         |           |                           | Revolutions    | Time      |           |         |
| 1       | Count     | 50 revolutions/2 minutes  |                | 2 minutes | 49 - 51   |         |
| 2       |           | 100 revolutions/4 minutes |                | 4 Minutes | 98 - 102  |         |
| 3       |           | 150 revolutions/6 minutes |                | 6 minutes | 147 - 153 |         |



# QUALIFICATION TAP DENSITY TESTER

# TAPPED DENSITY

- ❖ The tapped is an increased bulk density attained after mechanically tapping a container (graduated measuring cylinder) containing the powder sample.
- ❖ The tap density of a material (powder) can be used predict both flow properties and its compressibility.

## **URS FOR THE TAP DENSITY TESTER**

- Operating criteria must be adequate.
- Easy maintenance.

# URS FOR THE TAP DENSITY TESTER

- Equipment should not disseminate dust .
- Low cost
- Non reactive surface
- Capacity (100, 250 ml).

The test can be performed in 2 different modes

- USP mode
- User mode

# PHASES OF QUALIFICATION

- ❖ DESIGN QUALIFICATION
- ❖ INSTALLATION QUALIFICATION
- ❖ OPERATIONAL QUALIFICATION
- ❖ PERFORMANCE QUALIFICATION

# DESIGN QUALIFICATION

- The DQ outline the key features of the system designed to address the user requirements, regulatory compliance and selection rationale of a particular supplier.
- The following are the key considerations for DQ:
  - Physical dimensions of the equipment and accessories.
  - Health and safety requirement.
  - Suitable operating environment of the instrument.

# INSTALLATION QUALIFICATION

## DETAILS OF THE EQUIPMENT

- Equipment name, made by & mode no. shall be down.
- location for the installation equipment shall be checked .
- Utilities required shall be listed down.

## INSTALLATION PROCEDURE

- After changing all the specifications as mentioned in the selection criteria, service engineer shall commission the equipment.

# OPERATIONAL QUALIFICATION

- After completions of successful installation qualification initiate the actual operation to ensure that machine is operating within specification.
- Check the operation qualification parameters against their specification.
- Document the deviation details.
- The quality head and the department head shall decide whether deviation is acceptable or not.

# OPERATIONAL QUALIFICATION...

- It should supports have USP I (300 taps per min ) and USP II (250 taps per min) and ASTM test methods .
- It should have printer port for documenting test results as per GMP/GLP.
- The acoustic cabinet reduces the sound level to 71 dB to meet laboratory standards.



# PERFORMANCE QUALIFICATION

- Verifies that the equipment performs according to design specifications and user defined requirements in a reliable & reproducible manner under normal production conditions.
- Its determined by placing a graduated cylinder containing known mass or volume of drug formulation on a mechanical tapper apparatus, which is operated for a fixed numbers of tabs until the power bed volume has reached a minimum.

# QUALIFICATION OF TAP DENSITY TESTER

## INTRODUCTION

- ❑ The tap density testers series JV has been designed to measure the tap density of powders, granules and similar products in accordance with Methods 1 and 2 of USP chapter <616> and European Pharmacopoeia chapter 2.9.34.
- ❑ This technique is particularly useful in powder flowability studies and also in determining the amount of settlement during transit in order to optimise pack sizes e. g. washing powders.

# TAP DENSITY TESTER...

□ Tap density is achieved by mechanically tapping a measuring cylinder. (I .e .raising the cylinder and allowing it to drop the specified distance of  $3\pm 0.2$  mm under its own weight ) containing the sample under test.

## **TWO VERSIONS OF THE TESTER:**

- 1. JV 1000**
- 2. JV 2000**

# TAP DENSITY TESTER...



▲ JV 1000 with 1 x 250 mL Measuring Cylinder

▲ JV 2000 with 1 x 100 mL and 1 x 250 mL Measuring Cylinder

# TAP DENSITY TESTER...

- ❖ Both version utilise 250 mL measuring cylinders as standard; however , 100 mL cylinders (and smaller ) together with appropriate platforms are also available if required.
- ❖ Both of the instruments concerned are equipped with membrane keypads for setting the number of strokes or time and an LCD screen to set the appropriate parameters and monitor the progress of the test.

# MODE OF OPERATION

- The mode of operation is identical on both models .
- Weigh out a predetermined amount of the sample, say 100 g +/- 0.1%, place in the graduated cylinder provided and note the unsettled volume.
- Unless otherwise specified, set the number of taps via the membrane keypad on the front of the instrument to 500 and operate the device making a note of the resulting tapped volume.

# MODE OF OPERATION...

- Repeat the operation for a further 750 taps noting the volume once again.
- Continue repeating the test in increments of 1250 taps until the difference in tapped volume is less than 2% .note the final reading.

# CALIBRATION OF TAP DENSITY

## **SCOPE :**

- ❖ This scope shall provide the calibration procedure of tap density apparatus of quality control department.

## **RESPONSIBILITY :**

- ❖ Officer/Executive –quality control

## **ACCOUNTABILITY:**

- ❖ Head QC/QA



# CALIBRATION OF TAP DENSITY...

## PROCEDURE

- ❖ Before starting the operation check for the area cleanliness and instrument cleanliness.
- ❖ Connect the pain to power supply and switch on the power.
- ❖ Operate the instrument as per sop no BA (II) QA210, operation of tap density apparatus.
- ❖ The instrument shall be calibrated for the following parameters.
  - (a) The drop height of the cylinder holder
  - (b) The number of drops per minute of cylinder holder.

# CALIBRATION OF TAP DENSITY APPARATUS...

## CALIBRATION OF DROP HEIGHT IF CYLINDER HOLDER FOR USP 1 METHOD 1:

- Open the top cover by removing bottom screws.
- Turn the cam attached to the motor shaft clock wise, so that the cylinder holder shaft is at the minimum position.
- Make sure that the bottom plate of the cylinder holder is in perfect contact with the tapping platform.
- Measure the distance between the platform and clamp plate of cylinder holder; this reading is the base height( $H_r$ )...

## CALIBRATION OF DROP HEIGHT IF CYLINDER HOLDER FOR USP 1 ...

- Rotate the cam further by hand, clockwise till the cylinder holder shaft reaches maximum height.
- At this position the shaft tip should be on the falling edge of the cam arm. Mark this arm no-1.
- Make a mark on the point of measurement on the top plate of frame and on the cylinder plate.
- The difference between these two readings is drop height of the cylinder.
- Calibration of drop height of cylinder for USP 2 METHOD .
- Repeat the above all steps for all arms and record the results in the given format.

# CALIBRATION FOR NUMBER OF DROPS OF CYLINDER HOLDER PER MINUTE

- Set the instrument as per USP 1 method and operate the instrument.
- Paste a small piece of metal reflection paper on cam.
- Focus the light of tachometer on metal reflection paper sharply at a distance about 20 cm approximately.
- Multiply the rotation per minute which is displaying in tachometer by three and record the values in calibration format...

# CALIBRATION FOR NUMBER OF DROPS OF CYLINDER HOLDER PER MINUTE...

- Repeat the operation for 3 times and check the set number of tapings and record the values in calibration format.
- The number of drops should be between  $300 \pm 6$  drops.
- Similarly set the instrument as per USP 2 method and operate the instrument .
- Multiply the rotation per minute, which is displaying in tachometer by four and record the values in calibration format .
- The number of drops should be  $250 \pm 5$  drops...

## Scale of Flowability

| <b>Compressibility Index (%)</b> | <b>Flow Character</b> | <b>Hausner Ratio</b> |
|----------------------------------|-----------------------|----------------------|
| < 10                             | Excellent             | 1.00 - 1.11          |
| 11-15                            | Good                  | 1.12 - 1.18          |
| 16-20                            | Fair                  | 1.19 - 1.25          |
| 21-25                            | Passable              | 1.26 - 1.34          |
| 26-31                            | Poor                  | 1.35 - 1.45          |
| 32-37                            | Very poor             | 1.46 - 1.59          |
| > 38                             | Very, very poor       | > 1.60               |

# REFERENCES

- EA Guidelines on the Estimation of Uncertainty in Hardness Measurements , European Cooperation for accreditation, rEA -10/16, EV.00,Oct 2001.
- [https://www.pharmaguideline.com/hardness tester-calibration.html](https://www.pharmaguideline.com/hardness%20tester-calibration.html).
- <https://www.pharmaguideline.com/friability-calibrationofhardnesstester.html>
- <https://www.net/mobile/Ushakhanal3/qualification-of-tap-density>

•

# QUALIFICATION OF ANALYTICAL INSTRUMENTS



# CONTENTS

- Introduction Qualification
- Qualification Time Line
- Qualification phases
- Roles And Responsibilities
- AIQ Documentation
- FTIR
- FTIR Advantages And Disadvantage
- FTIR-applications
- Differential Scanning Calorimeter
- Types Of DSC Technologies
- DSC In Pharmaceutical Industry
- DSC calibration
- Conclusion
- References

# INDROCTION

- Analytical Instrument Qualification (AIQ) is documented evidence that an instrument performs suitably for its in-tended purpose and that it is properly maintained and calibrated. Use of a qualified instrument in analyses contributes to confidence in the veracity of generated data.
- The regulations also require the companies to establish procedures assuring that the instruments that generate data supporting regulated product testing are fit for use.
- The regulations, however, do not pro-vide clear and authoritative guidance for validation/qualification of analytical instruments.

# QUALIFICATION

Action of proving and documenting that equipment or ancillary systems are properly installed, work correctly, and actually lead to the expected results.

The qualification consists of four parts:

- Design qualification
- Installation qualification
- Operational qualification
- Performance qualification

# QUALIFICATION TIME LINE



# DESIGN QUALIFICATION

- The AIQ process timeline begins with the DQ phase at the vendor site , in which the instrument is developed ,designed, and produced in a validated environment according to good laboratory practice(GLP), and current good manufacturing practices(CGMP), and ISO standards.
- It describe the user requirements and defines the functional and operational specifications of the instrument. DQ should ensure that instrument to purchased have the necessary functions and performance that will enable for suitable intended application.28

# Installation Qualification(IQ)

Installation qualification is a documented collection of activities need to install an instrument in the users environment.

- system description
- Utilities/facility/environment
- Network and data storage
- Assembly and installation
- Installation verification

# Operational Qualification(OQ)

After a successful IQ the instrument is ready for OQ testing

The OQ phase may consist of these parameters.

- Fixed parameter
- Secure data storage , backup, and Archive
- Instrument functions tests

# Performance Qualification(PQ)

- Once on IQ and an OQ have been performed ,PQ testing is conducted.  
PQ testing should be performed under the actual running condition across the anticipated working range.
- The frequency depend on such parameter:
- Performance checks
- Preventive maintenance and repairs
- Standard operating procedure for operation, calibration, and maintenance
- Software validation
  - ✓ Firmware
  - ✓ Stand alone software
  - ✓ Instrument control, data acquisition, and processing software



# Change Control

- Change control follows the DQ/IQ/OQ/PQ classification process .
- For DQ , evaluate the change parameters, need for the change warrants implementing it.
- If the implementation of change is needed, install the changes to system during IQ.
- OQ and PQ test need revision, deletion, or addition as the result of the installed change.

# AIQ DOCUMENTATION

Two types of result from AIQ

- Static
- Dynamic

Static document:

This document obtained during the DQ,IQ and OQ phases and should be kept in a “qualification binder”.

Dynamic documents:

this document are generated during the OQ and PQ phases, when the instrument is maintained, or when it is tested for performance.

# Instrument Categories

- Modern laboratories typically include a suite of tools. These vary from simple spatulas to complex automated instruments.
- The users are the most qualified to establish the level of qualification needed for an instrument. Based on the level of qualification needed, it is convenient to categorize instruments into 3 groups: A, B, and C,
  - i) Group A Instruments
  - ii) Group B Instruments
  - iii) Group C Instruments

# Roles And Responsibilities

## **Users**

- Users are ultimately responsible for the instrument operations and data quality
- Users group includes analysts, their supervisors, and the organizational management. Users should be adequately trained in the instrument's use, and their training records should be maintained as required by the regulations.

## **Quality Assurance**

- The quality assurance (QA) role in AIQ remains as it is in any other regulated study. QA personnel should understand the instrument qualification process, and they should learn the instrument's application by working with the users. Finally, they should review the AIQ process to determine whether it meets regulatory requirements and that the users attest to its scientific validity.

# FTIR- Fourier Transform Infrared Spectroscopy

## INTRODUCTION

- FTIR stands for Fourier transform infrared, the preferred method of infrared spectroscopy. In infrared spectroscopy, IR radiation is passed through a sample. Some of the infrared radiation is absorbed by the sample and some of it is passed through (transmitted).
- The resulting spectrum represents the molecular absorption and transmission, creating a molecular fingerprint of the sample. Like a fingerprint no two unique molecular structures produce the same infrared spectrum.
- This makes infrared spectroscopy useful for several types of analysis.

# FTIR...

- A technique which is used to obtain an infrared spectrum of absorption, emission, photoconductivity or Raman scattering of a solid, liquid or gas.
- An FTIR spectrometer simultaneously collects spectral data in a wide spectra.



# Components of FTIR

- IR Radiation source
- Beam Splitter
- Fixed mirror
- Moving mirror
- Collimating mirrors
- Sample holder
- Helium Neon laser
- Detector

# FTIR - Working

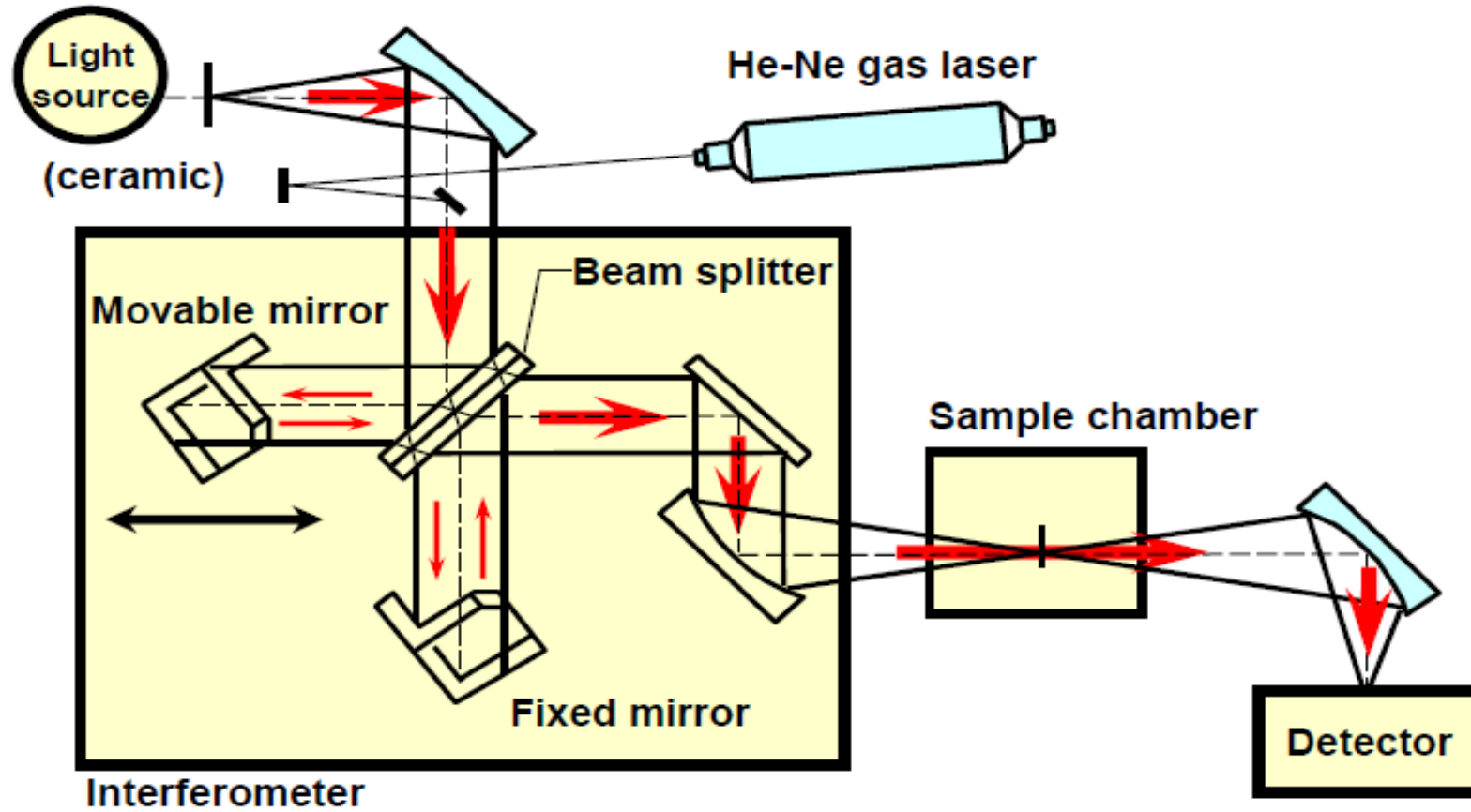



# Conceptual Introduction

- The goal of any absorption spectroscopy (FTIR, ultraviolet-visible ("UV-Vis") spectroscopy, etc.) is to measure how much light a sample absorbs at each wavelength. The most straightforward way to do this, the "dispersive spectroscopy" technique, is to shine a monochromatic light beam at a sample, measure how much of the light is absorbed, a Fourier-transform spectroscopy is a less intuitive way to obtain the same information.
- Rather than shining a monochromatic beam of light (a beam composed of only a single wavelength) at the sample, this technique shines a beam containing many frequencies of light at once and measures how much of that beam is absorbed by the sample. Next, the beam is modified to contain a different combination of frequencies, giving a second data point. This process is rapidly repeated many times over a short timespan. Afterwards, a computer takes all this data and works backward to infer what the absorption is at each wavelength

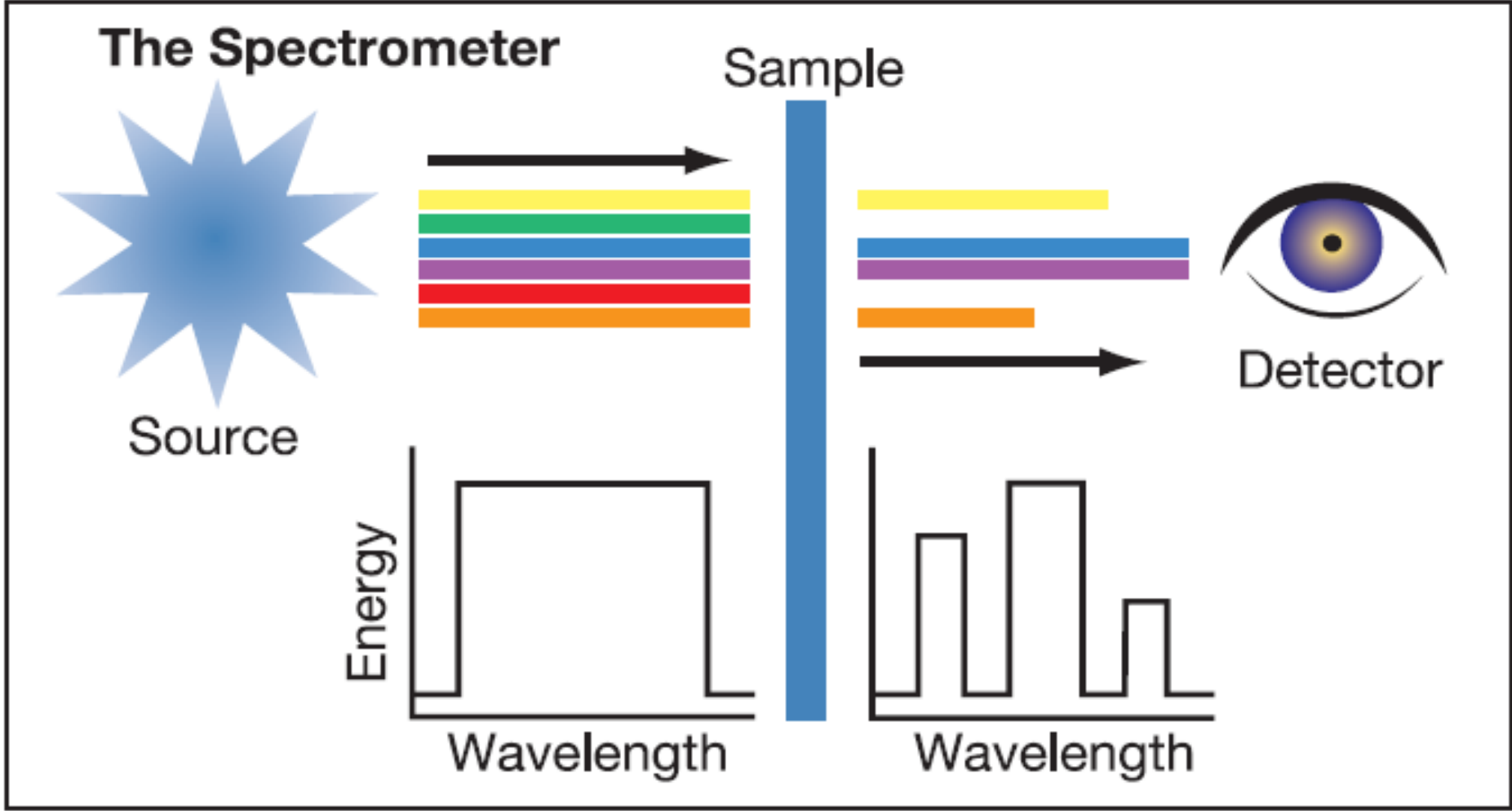

# Qualification of IR spectrophotometer

## INTRODUCTION

- The present document explains about “Qualification of Equipment (IR Spectrophotometer)”,

It should be used in combination with it when planning, performing and documenting the IR spectrophotometer qualification process.

- The document contains the Introduction and general forms for Level I and II of qualification, which are common to all type of instruments. For FTIR spectrometers, an example has been added to give instrument-specific proposals that may be used in combination with the general requirements presented in the core document "Qualification of Equipment", when drawing up a Level I checklist.

# Calibration

Calibration is the process by which ensure that an instrument readings are accurate the reference to establish standard. Calibration is performed by using primary standard. It is done to check the zero error deflection by using standard reference.

## **Calibration Management**

- Parts of a calibration management system
- Procedure(s)
- Documentation
- Calibration standards
- Calibration management software
- Calibration interval adjustment
- QOC/OOT evaluation
- What can go wrong and how to avoid it

# Wave Number Precision

This is performed for substances with well known peak wave number (s) position such as

- Carbon di oxide
- Water vapour
- Polystyrene
- Ammonia
- Test is performed to know whether the exact peak wave numbers are at that time of validation.
- Result between the peak wavenumbers position for a substance with a well known peak wave numbers and values indicated by the system.

## Wave Number Precision...

### 0 % Transmittance:

- A sample which do not allow the transmission of light is measured in order to investigate the 0 percentage transmittance.
- This test thus can be used to find out error caused by stray light and secondary emission spectra .

### 100 % transmittance:

- This is investigated by performing analysis with out a sample .
- By performing analysis with out sample 100 % transmittance can be investigated.

# Linearity of curve

- A calibration curve for the % transmittance and the concentration is created and the linearity of the inspected.
- Reproducibility:
- A stable sample is measured twice with in a short period and confirmed whether the variation in the measurement values such as wave numbers and transmittance are obtained.

# Validation of FTIR

- To perform FTIR validation and to confirm that it is operating properly, diverse IR inspection was performed by measuring the spectra of polystyrene film.

Installation of validation programme :

Software validates the Nicolet iS50 FTIR



## Design qualification

- Supplier must be provided documented evidence that the product has been designed, developed, manufactured in a quality environment e.g. iso 9001:2000 certification.
- Supplier must be provide phone and on site support in case of defects.
- Following information should be necessary in design qualification of FT-IR.

# Level I. Selection Of Instruments & Suppliers

## **Level I. Selection Of Instruments & Suppliers**

- Example of check-list (Non-Exhaustive)
- Manufacturer: \_\_\_\_\_
- Provider/ Distributor: \_\_\_\_\_
- Name Of Instrument and Type: \_\_\_\_\_

# Selection of Instruments & Suppliers...

| Attribute<br>(This list may be adapted if necessary)                   | Specifications   | Benefits<br>(Instrument/<br>supplier) | Assessment<br>(Pass/Fail) |
|--|--|---------------------------------------|---------------------------|
| SPECTROPHOTO<br>METER  |  |                                       |                           |
| Detector range   | The optical bench shall include a DTGS detector with a frequency range of 7400 to 350 cm-1 |                                       |                           |
| It shall include a Compressed interferometer                           | air  |                                       |                           |
| Spectral resolution  |  |                                       |                           |
| The instrument shall Come with an air-cooled Standard infrared source. |  |                                       |                           |

# Selection of Instruments & Suppliers...

| Attribute<br>(This list may be adapted if necessary)   | Specifications   | Benefits<br>(Instrument/supplier) | Assessment<br>(Pass/Fail) |
|--|--|-----------------------------------|---------------------------|
| Wave number accuracy   | The instrument shall have a spectral resolution not exceeding 1.0 cm <sup>-1</sup> |                                   |                           |
| The interferometer shall have at least four basic velocity levels: software shall permit the selection of a greater number of velocities between the basic levels. | Wave number accuracy shall be better than +/- 0.01 cm <sup>-1</sup>                |                                   |                           |
| The mirror's greatest velocity shall allow a speed of at least five sweeps per second  |  |                                   |                           |
| The laser and infrared beams must be coaxial to enable rapid, easy alignment of the system, depending on the samples or accessories                                |  |                                   |                           |

# Selection of Instruments & Suppliers...

| Attribute<br>(This list may be adapted if necessary)   | Specifications | Benefits<br>(Instrument/<br>supplier) | Assessment<br>(Pass/Fail) |
|--|----------------|---------------------------------------|---------------------------|
| The optical bench shall have main experimentation module with a device to allow purging with nitrogen                  |                |                                       |                           |
| At purchase, the main experimentation module shall be designed so it can receive 13 and 5 mm potassium bromide pellets |                |                                       |                           |

# Level II of Equipment Qualification or installation qualification

## Installation and Release for use

- It is recommended to check all requirements set during the selection of the instrument, and calibration should be performed before putting into service by an accredited external service supplier,  
or
- Internally by appropriately qualified personnel, using certified reference buffers according to an approved procedure.
- Correct software installation is verified
- The supplier instruction for installation is read

# Level III. Periodic & Motivated Instrument Checks or operational qualification

Examples of requirements for IR spectrophotometers

## **Parameters to be checked**

1. Wave-number scale
2. Detector energy ratio
3. Signal/Noise ratio
4. Resolution
5. Zero test
6. Contamination check (only for ATR instruments)
7. Throughput check (only for ATR instruments)

# 1. WAVE-NUMBER SCALE

## Method and Limits:

The wave-number scale may be verified by recording the spectrum of a polystyrene film, which has transmission minima (absorption maxima) at the wave numbers

(in  $\text{cm}^{-1}$ ) shown in the table below

| TRANSMISSION MINIMA<br>( $\text{cm}^{-1}$ ) | ACCEPTABLE TOLERANCE ( $\text{cm}^{-1}$ ) |                  |
|---|---|------------------|
|   | monochromatic<br>instruments              | FTIR instruments |
| 3060.0                                      | $\pm 1.5$                                 | $\pm 1.0$        |
| 2849.5                                      | $\pm 2.0$                                 | $\pm 1.0$        |
| 1942.9                                      | $\pm 1.0$                                 | $\pm 1.0$        |
| 1601.2                                      | $\pm 1.0$                                 | $\pm 1.0$        |
| 1583.0                                      | $\pm 1.0$                                 | $\pm 1.0$        |
| 1154.5                                      | $\pm 1.0$                                 | $\pm 1.0$        |
| 1028.3                                      | $\pm 1.0$                                 | $\pm 1.0$        |



## 2. DETECTOR ENERGY RATIO

### **Method:**

- Record the minimum energy ratio value for at least one of the following measurement points and compare it to the vendor's specifications: -
- Energy at 3990 cm<sup>-1</sup> / energy at 2000 cm<sup>-1</sup>
- Energy at 4000 cm<sup>-1</sup> / energy at 2000 cm<sup>-1</sup>
- Energy at 3400 cm<sup>-1</sup> / energy at 1300 cm<sup>-1</sup>
- Energy at 2000 cm<sup>-1</sup> / energy at 1000 cm<sup>-1</sup>

### **Limits:**

- Energy ratio test specifications vary for each spectrometer configuration. The optical bench shall include a DTGS detector with a frequency range of 7400 to 350 cm<sup>-1</sup>

# 3. SIGNAL/NOISE RATIO

## **Method:**

- Record the maximum noise level for each of the following regions:
- Peak-to-peak noise between:
  - 4050 cm<sup>-1</sup> and 3950 cm<sup>-1</sup>
  - 2050 cm<sup>-1</sup> and 1950 cm<sup>-1</sup>
  - 050 cm<sup>-1</sup> and 950 cm<sup>-1</sup>
  - 550 cm<sup>-1</sup> and 450 cm<sup>-1</sup>

(systems with DTGS detector only) RMS (root mean square) noise between:

- 4050 cm<sup>-1</sup> and 3950 cm<sup>-1</sup>
- 2050 cm<sup>-1</sup> and 1950 cm<sup>-1</sup>
- 1050 cm<sup>-1</sup> and 950 cm<sup>-1</sup>
- 550 cm<sup>-1</sup> and 450 cm<sup>-1</sup>

(systems with DTGS detector only)

## **Limits (% T):**

- Noise level test specifications vary for each spectrometer configuration.

## 4. RESOLUTION

### **Materials:**

- Certified polystyrene film of approximately 35  $\mu\text{m}$  in thickness.

### **Method:**

- For instruments having a monochromator, record the spectrum of the polystyrene film.
- For Fourier-transform instruments, use suitable instrument resolution with the appropriate apodisation prescribed by the manufacturer. This resolution is checked by suitable means, for example by recording the spectrum of a polystyrene film approximately 35  $\mu\text{m}$  in thickness.

### **Limits:**

- Difference between the absorbance's at the absorption minimum at 2870  $\text{cm}^{-1}$  and the absorption maximum at 2849.5  $\text{cm}^{-1}$   $> 0.33$ .
- Difference between the absorbance's at the absorption minimum at 1589  $\text{cm}^{-1}$  and the absorption maximum at 1583  $\text{cm}^{-1}$   $> 0.08$ .

## 5. ZERO TEST

### **Method:**

- When using a polystyrene film of approximately 35  $\mu\text{m}$  in thickness as standard at the wavelength of 2925  $\text{cm}^{-1}$  and 700  $\text{cm}^{-1}$  , almost complete absorption of the irradiated energy can be observed.
- With this test, the remaining transmission is measured. As the maximum absorption can be observed at 700  $\text{cm}^{-1}$  negative values may be observed.
- The objective of the test is to evaluate if, despite the fact that there is almost complete absorption, energy is still detectable.
- Non-valid results are an indication of a non-linear behaviour of the detector and the electronic system.

## 6. CONTAMINATION TEST

- (Only for Attenuated Total Reflection (ATR) instruments)

Note: If an automated system is available, this test can be run more frequently or it can be transferred to Level IV, to be run before each analysis.

# Level IV. In-use instrument checks examples of requirements for IR spectrophotometers

| Parameter to be checked  | Typical tolerance limits   |
|--------------------------|--|
| System suitability check | According to PH, EUR or MAH dossier or validated in – house method |

# Performance Qualification

## POWER SPECTRUM

- Power spectrum gives the plot of portion of signals power (energy per unit time ) falling within the given frequency bins .
- This test eliminates the intensity of power spectrum at a specified wave numbers.
- When the measured intensity is equal to or larger than the criterion value, the test is passed.

# Acceptance Criteria

| WAVE NUMBER(CM <sup>-1</sup> ) | STANDARD VALUE FTIR |
|--------------------------------|---------------------|
| 4600                           | 10% or min of max   |
| 4000                           | 25% or min of max   |
| 3000                           | 50% or min of max   |
| Power max value                | 50.0                |
| 700                            | 10% or min of max   |
| 500                            | 2% or min of max    |
| 403                            | 0.5% or min of max  |
| 351                            | 0.01% or min of max |

# Resolution

- The resolution is checked by recording the spectrum of polystyrene film of approximately 35 micro meter in thickness.
- The difference between %transmittance at absorption maximum A at 2870 and absorption minima B at 2849.5 must be greater than 18.
- The difference between percentage transmittance at absorption maxima c at 1589 and absorption minima 1583 must be greater than 12.



# Wave Number Accuracy

The wave number scale is usually calibrated by the use of several characteristic wave number of a polystyrene film.

3060.0(+/-1.5)cm<sup>-1</sup>

2849.5(+/-1.5)cm<sup>-1</sup>

1942.9(+/-1.5)cm<sup>-1</sup>

1601.2(+/-1.5)cm<sup>-1</sup>

1583.0(+/-1.5)cm<sup>-1</sup>

1154.5(+/-1.5)cm<sup>-1</sup>

1028.3(+/-1.5)cm<sup>-1</sup>

# Wave number reproducibility

- This program specifies three to measure the peak wave numbers.
- Then it obtains the actual peak wave numbers at each point by measuring the polystyrene film twice. It should satisfy 5  $\text{cm}^{-1}$  around 3000  $\text{cm}^{-1}$  of polystyrene absorption wave number, 1  $\text{cm}^{-1}$  around 1000  $\text{cm}^{-1}$ .
- The software determines whether the differences between each of two measurements are within the allowable range and it labels the result PASS if they are within the range.
- Ep 4.0 doesn't include this inspection.

# Transmittance reproducibility

- This program specifies peak wave number at three points and the transmittance at each point is measured it twice.
- The transmittance reproducibility should satisfy  $0.5\%T$  when the several point of polystyrene absorption from  $3000\text{ cm}^{-1}$  to  $1000\text{ cm}^{-1}$  are measured twice.
- Then it determined whether the differences between the two data are within the allowable range and it labels the result PASS if they in the range.
- All of above furnished data should be represented in.

## As per ASTM E1421-94 level Zero

- This software complies describes with in the description in the ASTM(American society for testing and materials).
- The FTIR abnormalities or large changes over short term and long term is assessed by these tests.
- The three parameters checked by this program are:

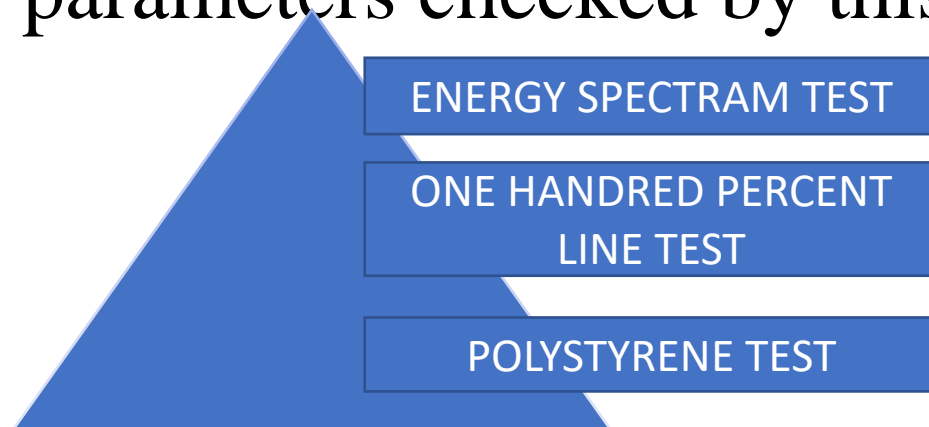

## ENERGY SPECTRUM TEST

- Power spectra obtain in the inspection are compared with reference data and the spectra are checked for the changes over long periods.

## ONE HUNDRED PERCENT LINE TEST

- 100% T line spectra are calculated for power spectra and are measured continuously in inspection and the spectra are checked for the changes over short periods.

## POLYSTYRENE TEST

- Polystyrene test data should be represented in validation report.
- Evaluation is performed using difference between spectra obtained for polystyrene film and in inspection and the stored reference data.
- All of the above furnished

## ADVANTAGES

- Better sensitivity and brightness
- High wavenumber accuracy
- Enhanced frequency Resolution
- Wavenumber range flexibility
- Less time consuming
- Data's can be stored & reanalysed

## DISADVANTAGES

- More expensive
- Require precision for mirror movement
- Detection of compound is influenced by
- Water vapour, path length & chemical interference

# Applications

- Opaque or cloudy samples
- High resolution experiments (as high as  $0.001 \text{ cm}^{-1}$  resolution)
- Trace analysis of raw materials or finished products
- Depth profiling and microscopic mapping of samples
- Kinetics reactions on the microsecond time-scale
- Analysis of chromatographic and thermo gravimetric sample fractions

# DIFFERENTIAL SCANNING CALORIMETER

- The differential scanning calorimeter (DSC) is a fundamental tool in thermal analysis. It can be used in many industries – from pharmaceuticals and polymers, to nanomaterial's and food products.
- A number of physical and chemical effects can be produced by temperature changes, and methods for characterizing these alterations upon heating or cooling a sample material are referred to as thermal analysis.
- The physical and chemical changes a sample undergoes when heated, are characteristic of the material being examined. By measuring the temperature at which such reactions occur and the heat involved in the reaction, the compounds present in the material can be characterized. The majority of known inorganic compounds have been so characterized.
- The physical and chemical changes that take place when unknown sample is heated provide the information that enables the identification of the material. These changes also indicate the temperature at which the material in question ceases to be stable under normal conditions.
- Common methods of thermal analysis are DSC, DTA, TGA, and TMA.



# Differential Scanning Calorimetry History

- This technique is developed by E.S.Watson and M.J.O'Neill in 1962.
- Introduced commercially at the Pittsburgh Conference on analytical Chemistry and Applied Spectroscopy.
- First Adiabatic differential scanning calorimeter that could be used in Biochemistry was developed by P.L.Privalov in 1964.

# Principle

- In DSC the heat flow is measured and plotted against temperature of furnace or time to get a thermo gram. This is the basis of Differential Scanning Calorimetry (DSC).
- The deviation observed above the base (zero) line is called exothermic transition and below is called endothermic transition.
- The area under the peak is directly proportional to the heat evolved or absorbed by the reaction, and the height of the curve is directly proportional to the rate of reaction.
- Calorimetry - The study of heat transfer during physical and chemical process.
- Calorimeter - A device for measuring the heat transferred.

## Principle...

- Differential scanning calorimetry (DSC) is a technique for measuring the energy necessary to establish a nearly zero temperature difference between a substance and an inert reference material, as the two specimens are subjected to identical temperature regimes in an environment heated or cooled at a controlled rate.
- It is the most widely used method of thermal analysis in pharmaceutical field.
- Thus, when an endothermic transition occurs, the energy absorbed by the sample is compensated by an increased energy input into the sample in order to maintain a zero temperature difference.
- Because this energy input is precisely equivalent magnitude of energy absorbed in transition, direct calorimetric measurement of transition is obtained from this balancing energy.
- On the DSC chart recording, the abscissa indicates the transition temperature and the peak measures the total energy transfer to or from the sample.

# What Does DSC Measure

- DSC measures the amount of energy (heat) absorbed or released by a sample as it is heated, cooled or held at constant temperature. DSC also performs precise temperature measurements.

## Used

- Melting point
- Crystallization
- Glass Transition

## **O.I.T. (Oxidative Induction Time)**

It is a standardized test performed in DSC that measures the level of stabilization of the material tested. The time between melting and onset of decomposition in isothermal conditions is measured.

- Polymorphism
- Purity
- Specific Heat
- Kinetic Studies

**Curing Reactions** - The process in which an adhesive undergoes a chemical reaction and becomes a solid by forming a bonded joint. The reaction may be initiated by heat, light, UV radiation, water etc.

**Denaturation** - A process pertaining to change in the structure of a protein from regular to irregular arrangement of polypeptide chains.

# Conventional DSC



- **In general an endothermic reaction on a DSC arises from**
- Desolvations
- Melting
- Glass transitions and
- Decompositions.

## Conventional DSC...

**An exothermic reaction measured by DSC is usually indicative of molecular reorganizations such as**

- 1) Crystallization
- 2) Curing
- 3) Oxidation.

The differential heat input is recorded with a sensitivity of  $\pm 0.1$  mill calories per second and the temperature range over which the instrument operates is  $-175^{\circ}\text{C}$  to  $725^{\circ}\text{C}$ .

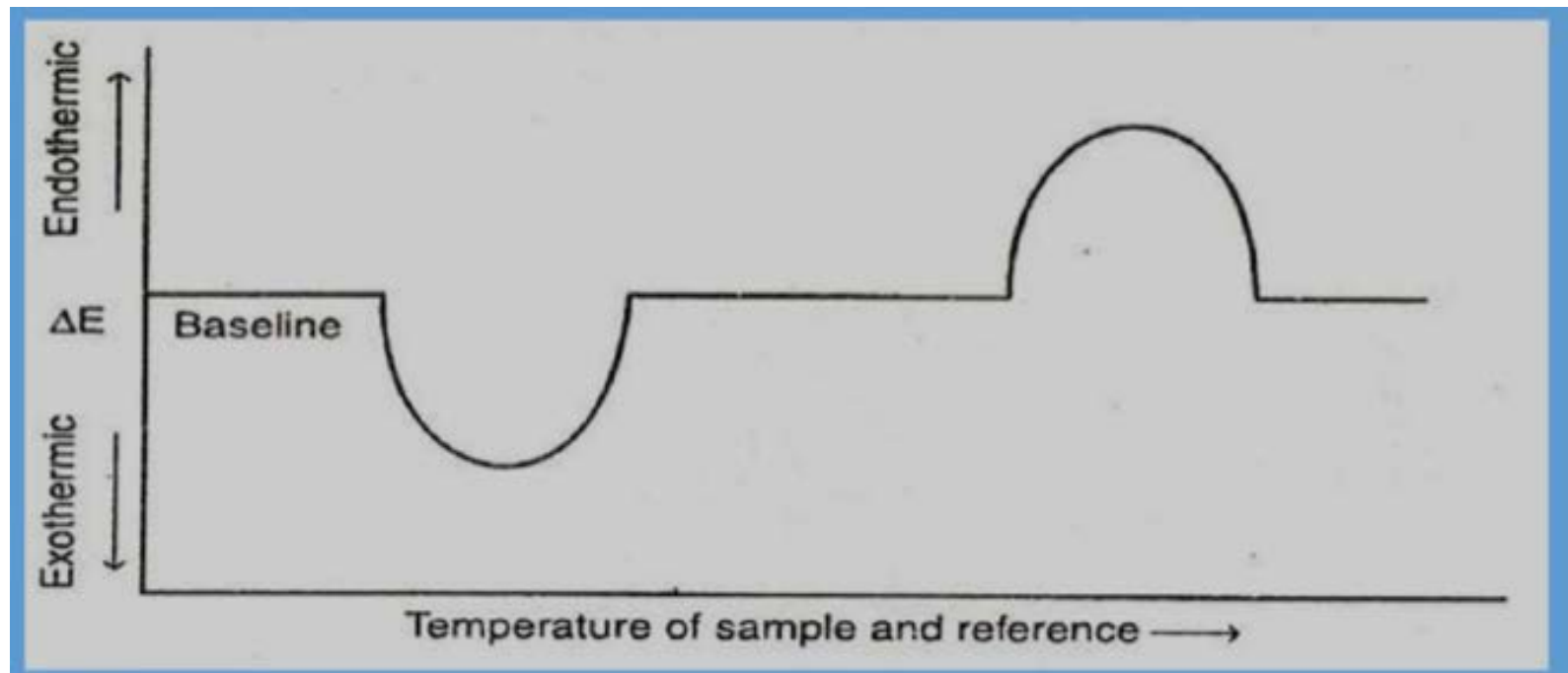

# Endothermic Heat Flow

- Heat Flow

- Endothermic: heat flows into the sample as a result of either heat capacity (heating) or some endothermic process (glass transition, melting, evaporation, etc.)

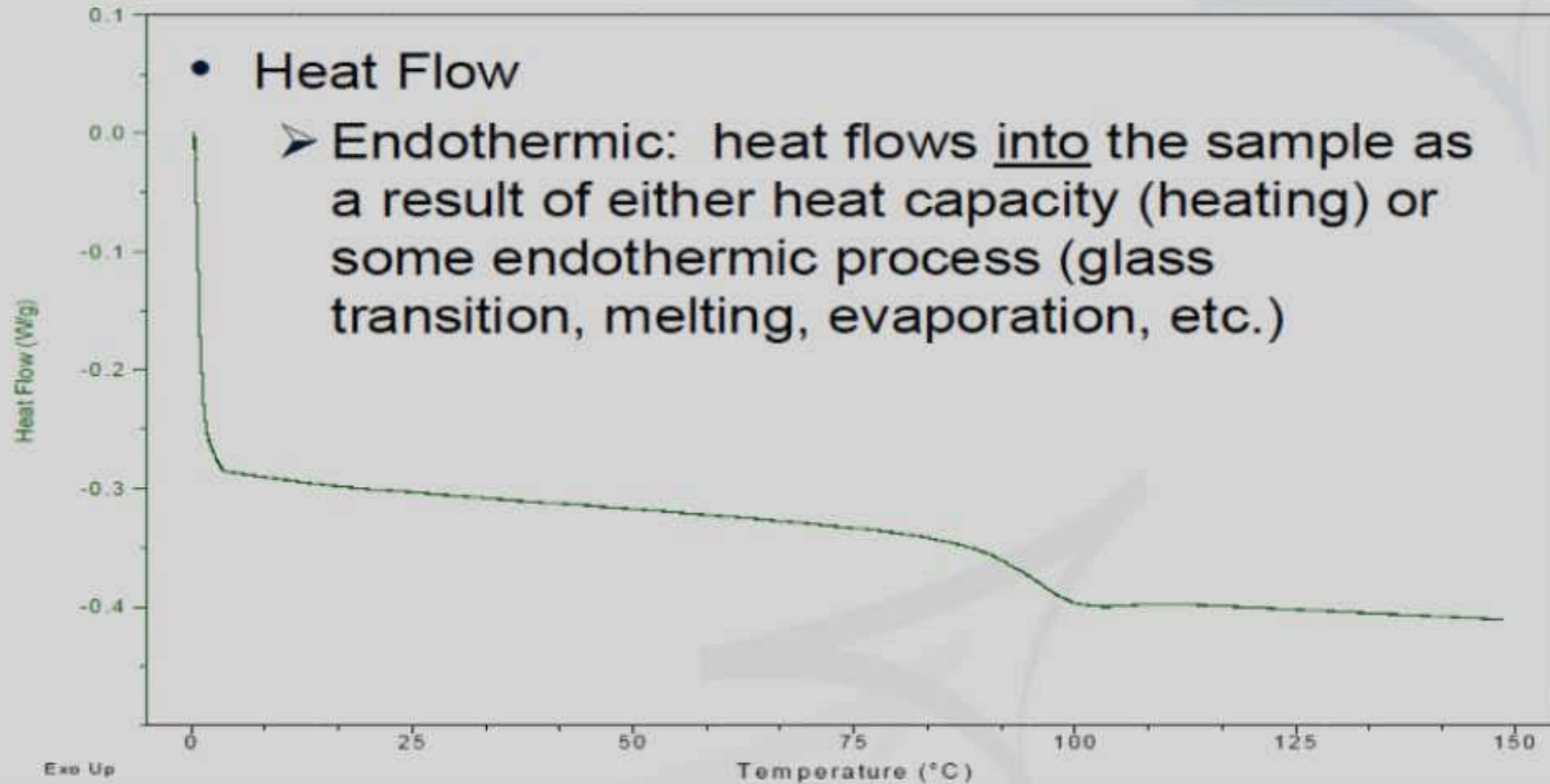



# Exothermic Heat Flow

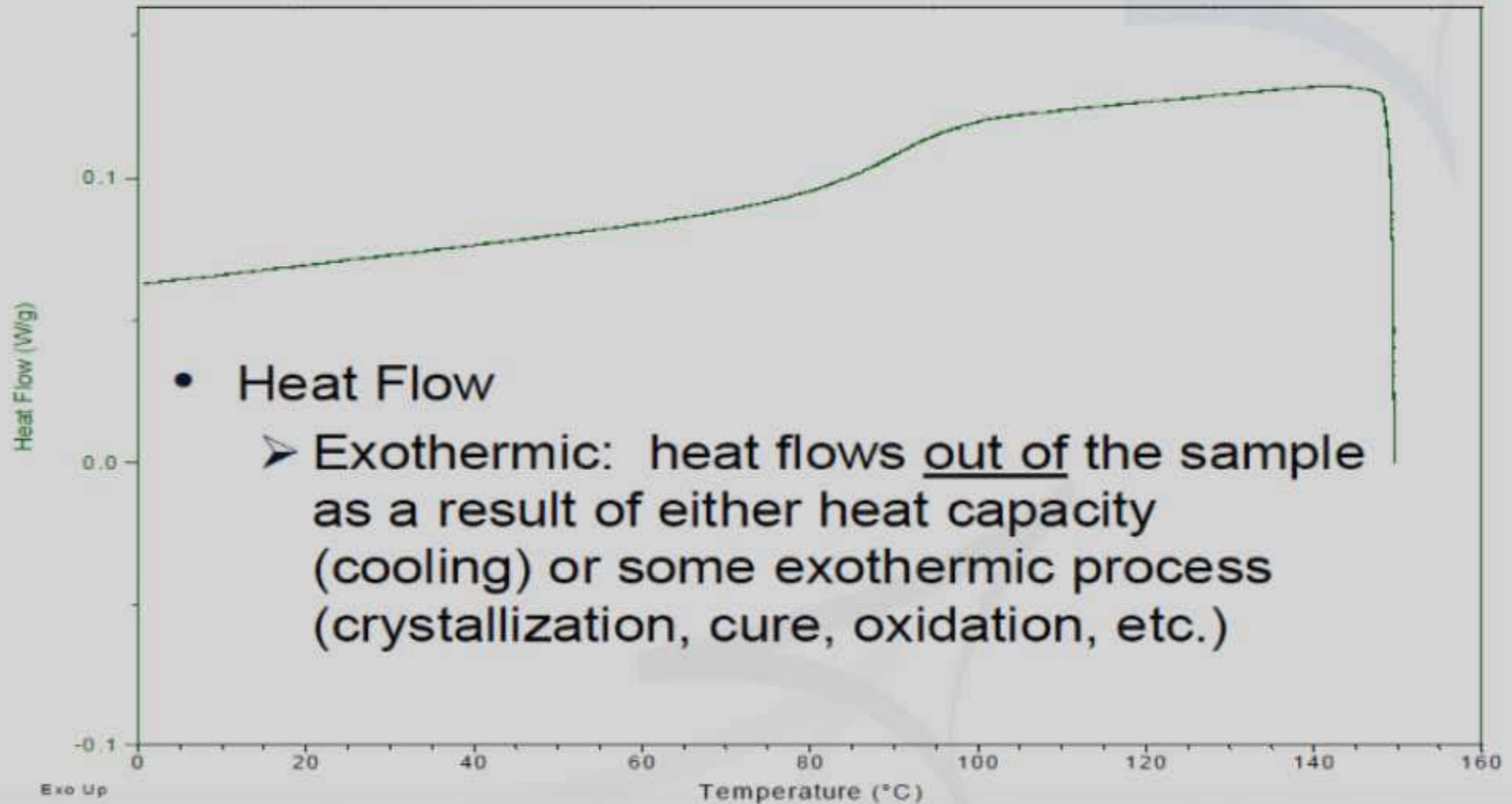

- Heat Flow

- Exothermic: heat flows out of the sample as a result of either heat capacity (cooling) or some exothermic process (crystallization, cure, oxidation, etc.)

# DSC Thermogram

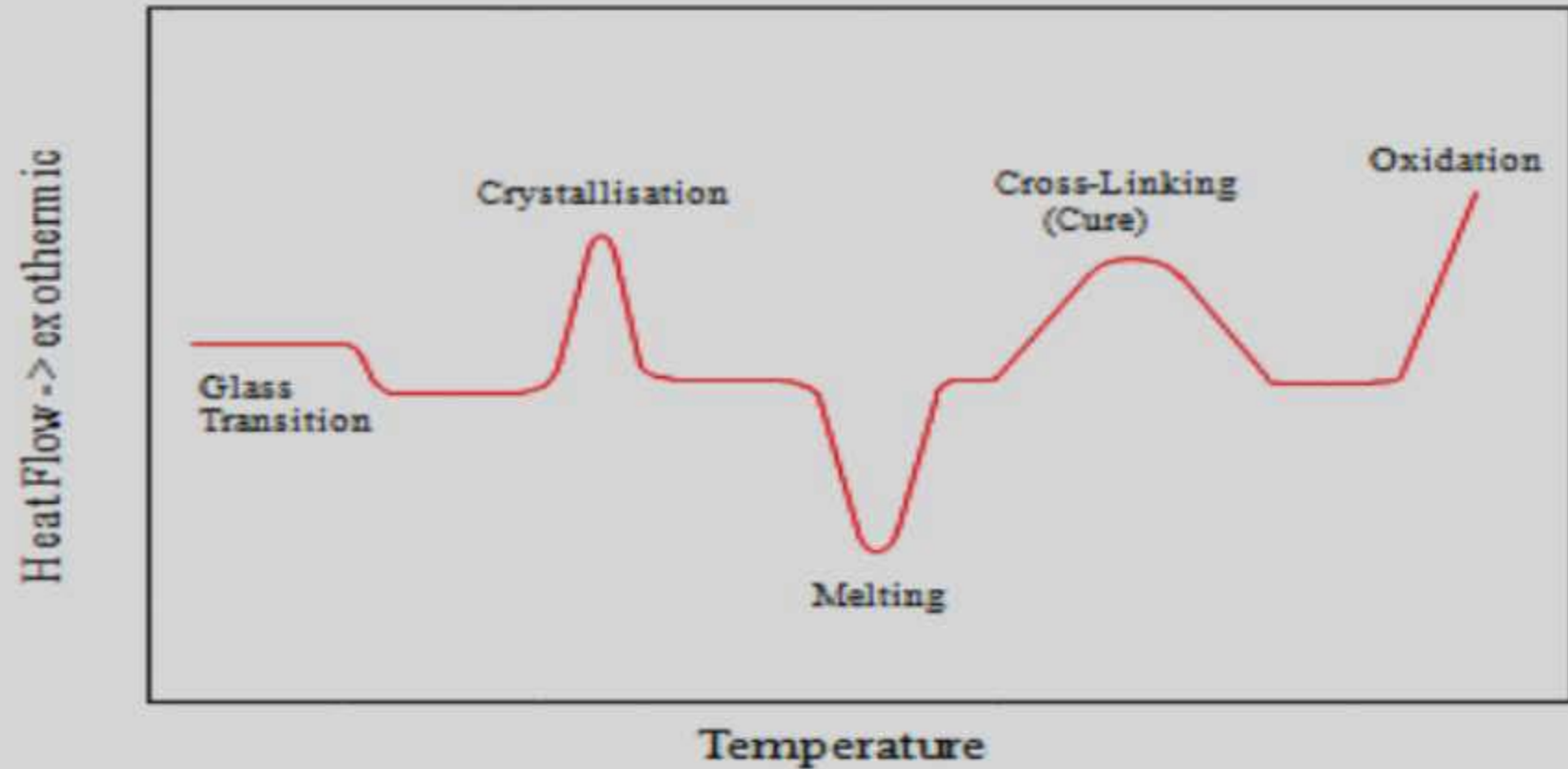

# Types of DSC Technologies

Two basic types of DSC instruments:

- Power compensation DSC and
- Heat-flux DSC

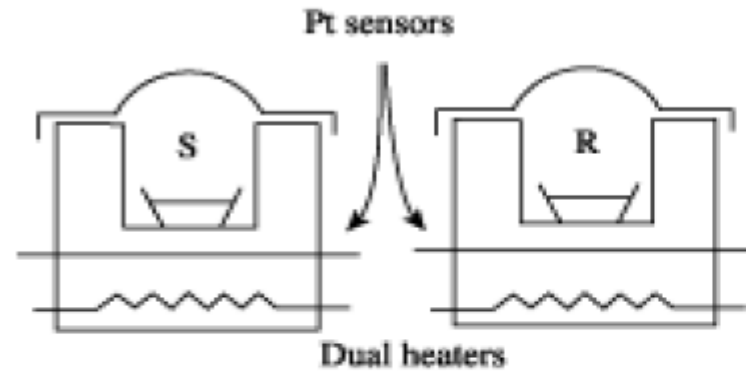

Power compensation DSC

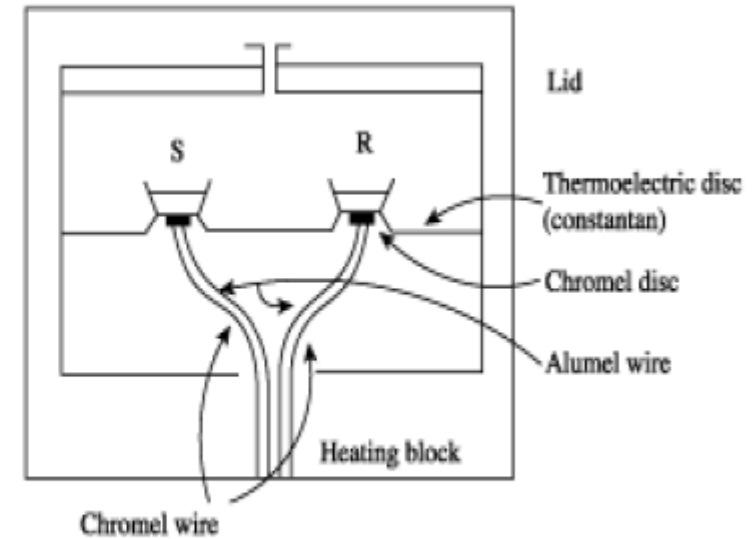

Heat flux DSC

# Power Compensation DSC

It is developed by Perkin Elmer, USA. It directly measures heat flow between sample side and reference side using two separate, low mass furnaces.

**Principle:** An exothermic or endothermic change occurs in the sample, when the sample is heated, power (energy) is applied or removed from the furnace to compensate for the energy change occurring in the sample is measured.

- The system is maintained in “Thermal Null” state all the times.
- The amount of power required to maintain the system in equilibrium is directly proportional to the energy changes.
- Sample holder - it is made up of aluminium, platinum or stainless steel.
- Sensors - platinum resistant sensors are generally used. Separate sensors are used for are used for sample and reference cells.
- Furnace - separate blocks of furnace are used for sample and reference cells.
- Temperature controller - differential thermal power is supplied to heaters to maintain the temperature of the sample and reference at the programmed value.

# Power Compensation DSC

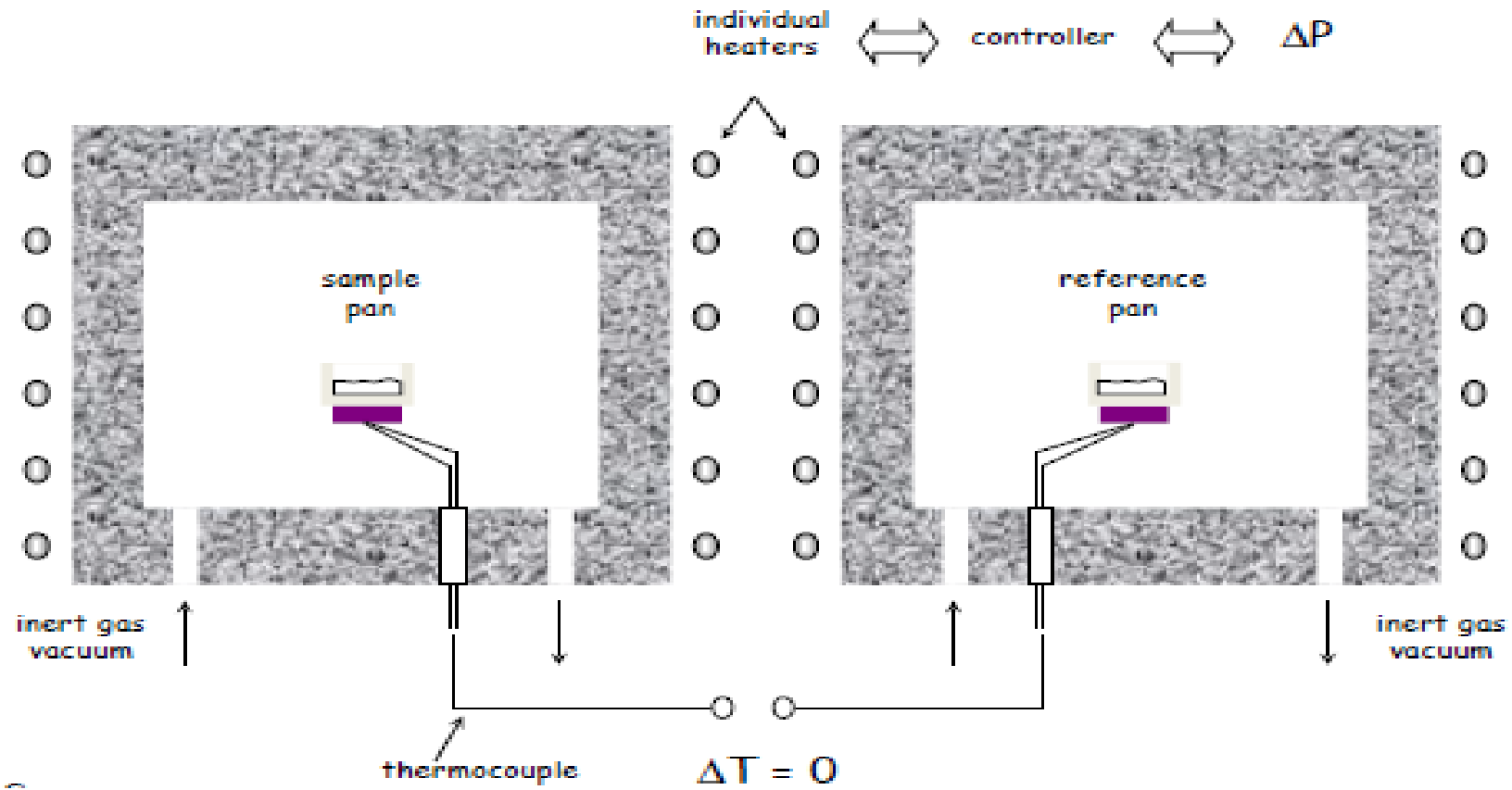

# Heat Flux DSC

- It is proposed by Boersma.
- The sample and reference cells are heated at a constant rate and thermocouples are used to detect the temperature
- differential between sample side and reference side using single, large mass furnace.

## **Principle**

- The introduction of a controlled heat leak between the sample and reference holders enabled a quantitative measurement of energy changes to be made. Heat flux can be measured directly if a sample is surrounded by a thermopile.
- The peak area is related to the enthalpy change by a calibration factor which is partially temperature dependent

## Heat Flux DSC...

**Sample holder** - sample and reference holders are connected by a low resistance heat flow path. The material with which the sample holder is made may be aluminium, stainless steel, platinum.

- **Sensors** - temperature sensors are thermocouples.
- **Furnace** - same block is used for sample and reference.
- **Temperature controller** - temperature difference between sample and reference is measured.
- A metallic disc made of constantan alloy is the primary means of heat transfer. Sample and reference sit on raised constantan discs.
- Differential heat flow to sample and reference is measured by thermocouples which are connected in series, located at the junction of constantan disc and chromel wafers.
- With this, it is possible to achieve heating or cooling rates of 1000c /min to 00c /min(isothermal).

It needs mathematical equations to get the heat flow.  $\mathbf{Dh/Dt = Cp Dt/Dt + F(t,t)}$

DSC Heat Flow Equation

- **Dh/Dt** - DSC Heat Flow Signal, **Cp** - Sample Heat Capacity = Sample Specific Heat X Sample Weight, **Dt/Dt** - Heating Rate
- **F(t,t)** - Heat Flow That Is A Function Of Time At An Absolute Temperature (Kinetic)

# Instrumentation

This instrument works on the temperature control of two similar specimen holders.

## **It consists of two circuits**

1. Left half - differential temperature control circuit
2. Right half - average temperature control circuit
  - In the average temperature control circuit an electrical signal which is proportional to the dialled temperature of the sample and reference holders, is generated through the programmer.
  - In the differential temperature control circuit, signals representing the temperature of sample and reference are compared. If no reaction taking place in the sample, the differential power input to the sample and reference heater is almost zero. If a reaction is taking place ( $\Delta H$  is not zero) a differential power is fed to heaters. A signal proportional to this differential power along with the sign is transmitted to the recorder pen. The integral of the peak so obtained gives the internal energy change of the sample.



## **Cleaning The Sample Cell**

- If the cell gets dirty – Clean it with brush
- Brush gently both sensors and cell if necessary
- Be careful with T zero™ thermocouple
- Blow out any particles are remaining.

# Block Diagram For DSC Instrument

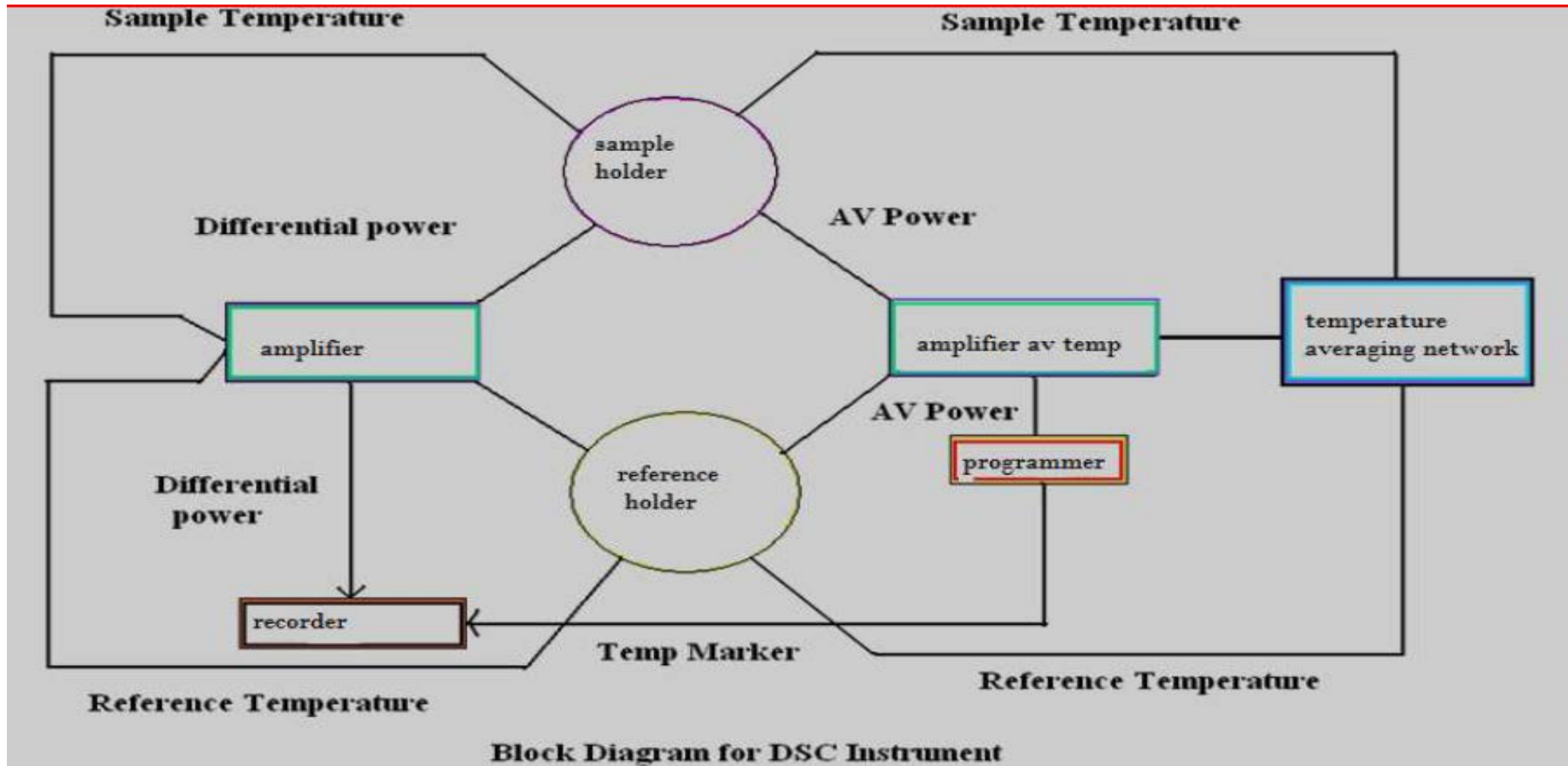

## DSC Instrument...

- **Reference Materials** - An inert material like  $\alpha$ -alumina is generally used. Empty pan can also be used, if the sample weight is small. With higher sample weights it is necessary to use a reference material, because the total weight of the sample and its container should be approximately the same as the total weight of the reference and its container.
- The reference material should be selected so that it possesses similar thermal characteristics to the sample. The most widely used reference material is  $\alpha$ -alumina, which must be of analytical reagent quality. Before use,  $\alpha$ -alumina should be recalcined and stored over magnesium perchlorate in a desiccator.
- Kieselguhr is another reference material normally used when the sample has a fibrous nature. If there is an appreciable difference between the thermal characteristics of the sample and reference materials, or if values of  $\Delta T$  are large, then dilution of the sample with the reference substance is sensible practice. Dilution may be accomplished by thoroughly mixing suitable proportions of sample and reference material.

## DSC Instrument...

- **Purge Gases** - Sample may react with air and may oxidize or burn. The problem is overcome by using inert gases. Inert gases are used to control moisture in the surrounding atmosphere. Commonly used inert gases are nitrogen, helium, argon etc. Inert gases should ensure even heating and helps to sweep away the off gases that might be released during sublimation or decomposition.
- **Nitrogen** - It is the most commonly used inert gas. It increases the sensitivity of the experiment. Typical flow rate is 50 ml/min.
- **Helium** - It has high thermal conductivity. It increases the resolution of the peaks. The upper temperature limit for this gas is up to 3500c. Flow rate is 25 ml/min
- **Air or oxygen** - Sometimes it is deliberately used to view oxidative effects of the sample. Flow rate is 50 ml/min
- **Heating Rate** - Faster heating rate will increase the sensitivity but will decrease the resolution. Slow heating rate will decrease the sensitivity but will increase the resolution. Good starting point is 100 24-12-2015 c/min.

# Factors Affecting Thermogram

## **Sample shape:**

The shape of the sample has little effect on the quantitative aspect of DSC but more effect on the qualitative aspects. However, samples in the form of a disc film or powder spread on the pan are preferred. In the case of polymeric sheets, a disc cut with a cork-borer gives good results.

## **Sample size:**

- About 0.5 to 10mg is usually sufficient. Smaller samples enable faster scanning, give better shaped peaks with good resolution and provide better contact with the gaseous environment. With larger samples, smaller heats of transitions may be measured with greater precision.

## **1) Heating rates**

## **2) Atmosphere and geometry of sample holders**

- There are a number of variables that affect DSC results includes the type of pan, heating rate, the nature and mass of the compound, the particle size distribution, packaging and porosity, pre-treatment and dilution of the sample. It is used for purity analysis of 98% pure compounds.

# DSC Calibration

## Baseline

- Evaluation of the thermal resistance of the sample and reference sensors
- Measurements over the temperature range of interest

## 2-Step process

- The temperature difference of two empty crucibles is measured
- The thermal response is then acquired for a standard material, usually sapphire, on both the sample and reference platforms
- Amplified DSC signal is automatically varied with the temperature to maintain a constant calorimetric sensitivity with temperature

## DSC Calibration...

### Temperature

Goal is to match the melting onset temperatures indicated by the furnace Thermocouple readouts to the known melting points of standards analyzed by DSC Should be calibrated as close as possible to the desired temperature range.

### Heat flow

Use of calibration standards of known heat capacity, such as sapphire, slow accurate heating rates (0.5–2.0°C/min), and similar sample and reference pan weights

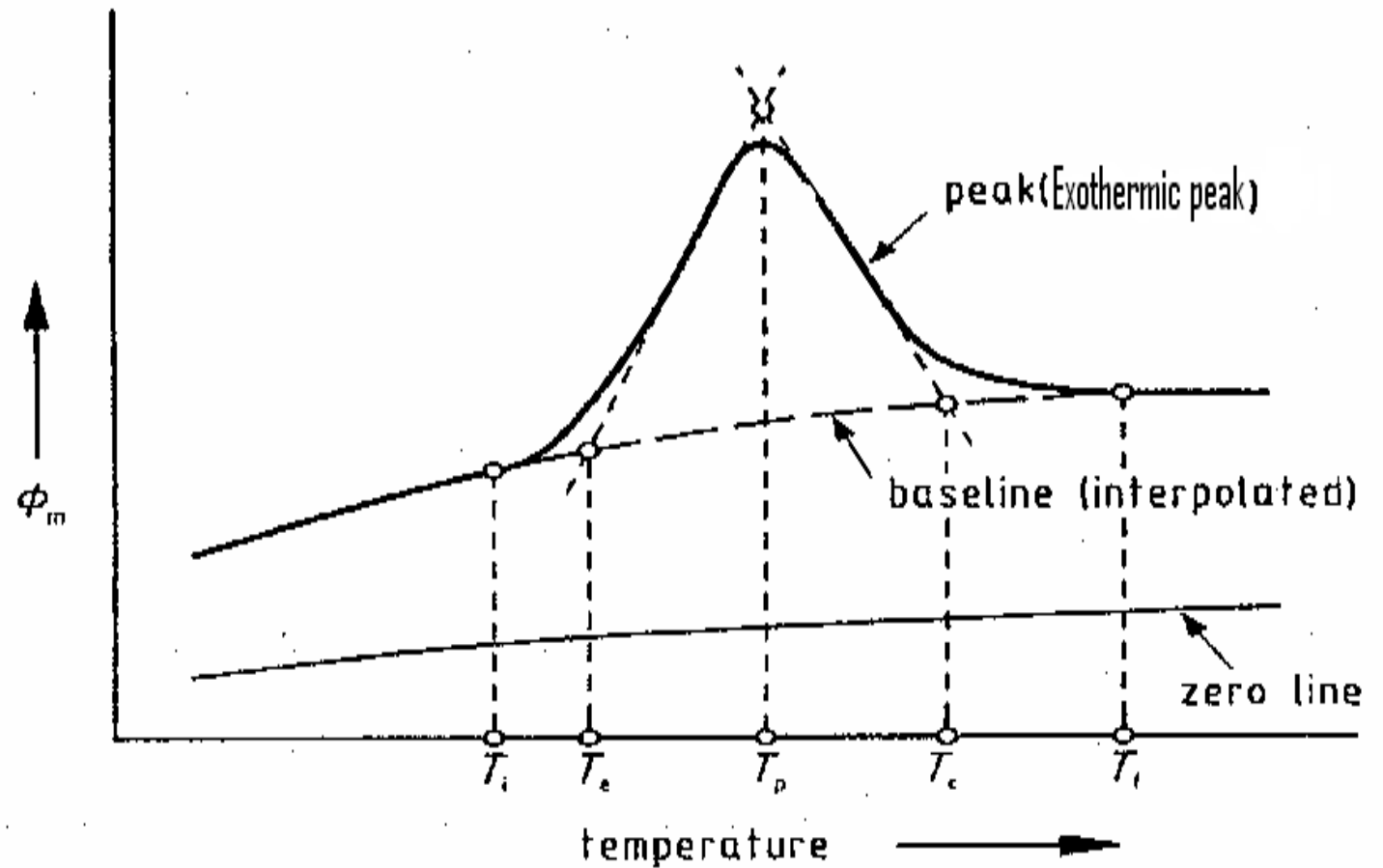

## DSC Calibration...

### **Calibrants**

- High purity
- Accurately known enthalpies
- Thermally stable
- Light stable (hv)
- Non-hygroscopic
- Un-reactive (pan, atmosphere)

### **Metals**

- Indium
- Stannous
- Aluminium

### **Inorganics**

- KNO<sub>3</sub>
- KClO<sub>4</sub>

### **Organics**

- Polystyrene
- Benzoic acid
- Anthracene



# DSC Curve

- The result of a DSC experiment is a curve of heat flux versus temperature or versus time. There are two different conventions: exothermic reactions in the sample shown with a positive or negative peak, depending on the kind of technology used in the experiment.
- This curve can be used to calculate enthalpies of transitions, which is done by integrating the peak corresponding to a given transition. The enthalpy of transition can be expressed using equation:
- $\Delta H = KA$

## DSC Curve...

- Where  $\Delta H$  is the enthalpy of transition,
- $K$  is the calorimetric constant,
- $A$  is the area under the peak.
- The calorimetric constant varies from instrument to instrument, and can be determined by analysing a well-characterized material of known enthalpies of transition.
- Area under the peak is directly proportional to heat absorbed or evolved by the reaction,
- height of the peak is directly proportional to rate of the reaction

# Factors affecting DSC curve

Two types of factors effect the DSC curve

## Instrumental factors

a- Furnace heating rate

b- Recording or chart speed

c- Furnace atmosphere

d- Geometry of sample holder/location of sensors

e- Sensitivity of the recoding system

f-Composition of sample containerises of factors effect the DSC curve

# Factors affecting DSC curve...

## Sample characteristics

- a- Amount of sample
- b- Nature of sample
- c- Sample packing
- d- Solubility of evolved gases in the sample
- e- Particle size
- f- Heat of reaction
- g- Thermal conductivity

# Factors affecting DSC curve...

## Application

- Protein Stability and Folding
- Liquid Biopharmaceutical Formulations
- Process Development
- Protein Engineering
- Rank order Binding
- Antibody Domain Studies
- Characterisation of Membranes, lipids, nucleic acids & micellar systems
- Assessment of the effects of structural change on a molecules stability
- Measurement of Ultra-light molecular interactions
- Assessment of bio comparability during manufacturing.

# Calibration of DSC

- Design specification:

| Principle         | Heat flux type                         |
|-------------------|--|
| Heat flow range   | +or – 40 micro W                       |
| Hold time         | 0-999 min, hour                        |
| Noise level       | 1 microwW                              |
| Size(mm)          | 300wx 490Dx 290H                       |
| Temperature range | -150to 600 degree celcius              |
| Programme rate    | 0-99 degree K /min,K/hour              |
| Cooling time      | About 6 mins from 600 degree c to 40 c |
| Atmosphere        | Inert gas or air                       |
| Power supply      | 100/120 VAC800AV                       |

# Installation Qualification

- The DSC should be
- In a temperature controlled area (15 degree C to 30 degree C)
- A clean environment
- An area with ample working and ventilation space.
- On
- A stable , heat resistant , and fire resistant work surface

## Performance Qualification

- The most common procedure is to run an indium standard under the normal test condition and measure the heat of fusion value and melting onset temp.
- For many industries limits of:
- $\pm 0.5$  degree celcius for temperature or 1% for heat of fusion may be accepted, though tighter limits  $\pm 0.3$  degree celcius and 0.1% may also be adopted.



## Baseline slope calibration

- This calibration involves heating an empty cell through the entire temp range expected in subsequent exp.
- Empty standard DSC cell run from 25 to 400 degree celcius.
- Heat flow signal should be 0.
- No sample cell and it should have minimum slope.

# Temperature Calibration

- Establishment of relationship between temperature measured  $T_{\text{meas}}$  and true temperature  $T_{\text{tr}}$ .
- $T_{\text{true}} = T_{\text{meas}} + \Delta T_{\text{corr}}(T_{\text{meas}})$
- Enthalpy calibration:
- Establishment of the relationship between enthalpy change measured  $\Delta_{\text{trs}}_{\text{meas}}$  and the true enthalpy change  $\Delta_{\text{trs}}_{\text{H}}$  absorbed or released by sample as result of a transition at the transition temperature  $T_{\text{trs}}$ .
- $\Delta_{\text{trs}}_{\text{H}} = k_{\text{H}}(T_{\text{tr}})\Delta_{\text{H}}_{\text{meas}}$
- Heat flow calibration

# CONCLUSION

- The purpose of the analytical instrument is to generate reliable data.
- The qualification of analytical instrument has become a subjective and often fruitless document generating exercise.
- Ability to use of instrument to deliver reliable and consistent data.

# REFERENCES

Jddtonline info>pdf on overview analytical instrument qualification.

[www.usp-pqm](http://www.usp-pqm.org) .org >article of analytical instrumentation.

[http://www.slideshare](http://www.slideshare.net) net >qualification of analytical instrument.

<http://www.perkinelmer.com> >pdf DSC PerkinElmer.

# QUALIFICATION OF UV- VISIBLE SPECTROPHOTOMETER

# UV-VISIBLE SPECTROPHOTOMETER

- ❖ **Spectrometer** refers to a spectrometer or spectrophotometer which operates in the region of the electromagnetic UV and or Visible spectrum.
- ❖ **UV - Visible spectroscopy** is concerned with ultra violet and visible region which ranges from 200 to 800nm

# Introduction

- ❖ **VALIDATION:** It is a act of demonstrating and documenting that the process operates effectively and reproducibly to produce a product meeting effectively and reproducibly to produce a product meeting its predetermined specification and quality attributes
- ❖ **CALIBRATION:** Calibration is a comparison between measurements – one of known magnitude or correctness made or set with one device and another measurement made in as similar a way as possible with a second device

# Introduction...

- ❖ **QUALIFICATION** : It is part of validation but the individual qualification steps alone do not constitute process validation
- ❖ Qualification is an act or process to assure something complies with some conditions standard or specific requirements
- ❖ There are 4 phases
  1. Design qualification
  2. Installation qualification
  3. Operational qualification
  4. Performance qualification



# 1.Design qualification

- ❖ DQ defines the user requirement specification (URS), and details the conscious decisions in the selection of the supplier. Thus it defines the overall requirements for the instrument, the key performance characteristics of the instrument and ranges over which the instrument is required to operate and consistently perform, and other critical factors relating to its use.

## 2. Installation qualification

- ❖ IQ covers all procedures relating to the installation of the instrument in the selected environment. IQ establishes that the instrument is received as designed and specified, that it is properly installed in the selected environment, and that this environment is suitable for the operation and use of the instrument.

## 3.Operational qualification

- ❖ OQ is the process of undertaking confirmatory checks to verify key aspects of performance in the absence of any contributory effects which may be introduced by the method

## 4.Performance qualification

- ❖ PQ is defined as the process of demonstrating that an instrument consistently performs according to a specification appropriate for its routine use.

# 1.Design qualification

| Single beam and double beam mode | Allow both modes   |
|----------------------------------|--|
| Wavelength range                 | 190nm - 900nm  |
| Photometric range                | Photometric range  |
| Lamp switching                   | Allow both modes manual or automatic                     |
| Band width                       | 0.2 nm - 4.0 nm or better, with 0.1 nm of increments     |
| Wavelength accuracy              | Minimum of $\pm 0.2$ nm                                  |
| Wavelength reproducibility       | 0.05 nm or better  |
| Wavelength resolution            | 0.2 nm or better   |
| Photometric stability            | after 2 hour should not be more than 0.0005 Abs. units/h |

## 2. Installation site :

- ✓ Room temperature during use of 15 to 35°C
- ✓ Out of direct sunlight
- ✓ No strong vibration or continuous weak vibration
- ✓ No strong magnetic fields or electromagnetic fields
- ✓ Humidity of 45 to 80%
- ✓ No corrosive gases or organic or inorganic gases with absorptivity in the ultraviolet range
- ✓ Small amount of dust

## Installation procedure :

- While the UV instrument was shipped after the precise adjustment and inspection at the area , its recommended to install according to the following procedures so as to provide its optimum performance and meet the user's demands

# Acceptance procedure

| Item to be checked          | specification  |
|-----------------------------|--|
| Appearance                  | No defect  |
| Number of parts             | No missing parts   |
| Rom check                   | Latest version   |
| Linearity of absorbance     | Bent: $\pm 0.002$ Abs<br>Shock noise: $\pm 0.004$ Abs          |
| Noise level                 | Noise width : $\pm 0.002$ Abs<br>Shock noise : $\pm 0.004$ Abs |
| Accuracy of wavelength      | $\pm 0.5$ nm   |
| Repeatability of wavelength | $\pm 0.1$ nm   |

## 3. Operation qualification

| Parameter to be checked               | Typical tolerance limits   |
|---------------------------------------|--|
| Spectral slit –width (if applicable ) | $\pm 10\%$   |
| Wavelength accuracy                   | $\pm 1$ nm for the UV range<br>$\pm 3$ nm for the Visible range                      |
| Photometric accuracy                  | $\pm 0.003$ Abs .units or for 1.0 Abs  |
| Photometric linearity                 | $r^2$ 0.999  |
| Limit of stray light                  | A >2.0 AT 198 nm   |
| Baseline noise                        | $\pm 0.002$ Absorbance units(500 nm)<br>$\pm 0.01$ Absorbance units (200,300,400 Nm) |
| Photometric drift                     | $\pm 0.001$ Absorbance units/h (250 nm )<br>$\pm 0.002$ Absorbance units/h (500 nm ) |



# Calibration of UV-VIS spectrophotometer

- ❖ Resolution
- ❖ Wavelength accuracy
- ❖ Stray light
- ❖ Resolution
- ❖ Photometric accuracy
- ❖ Noise
- ❖ Baseline flatness
- ❖ Stability
- ❖ Spectral slit width

## Calibration ...

### ❖ Resolution power:

The resolution of a UV-VIS spectrophotometer is related to its spectral bandwidth(SBW). The smaller the spectral width, the finer the resolution

The SBW depends on the slit width and the and the dispersive power of the monochromator

### ✓ Test:

0.02%v/v toluene in hexane is used to test the resolution power of the spectrophotometer. The absorbance measured at 269nm and 266

✓ Acceptance:

The ratio of the absorbance at 269 nm absorbance at 266 nm should be greater than 1.5

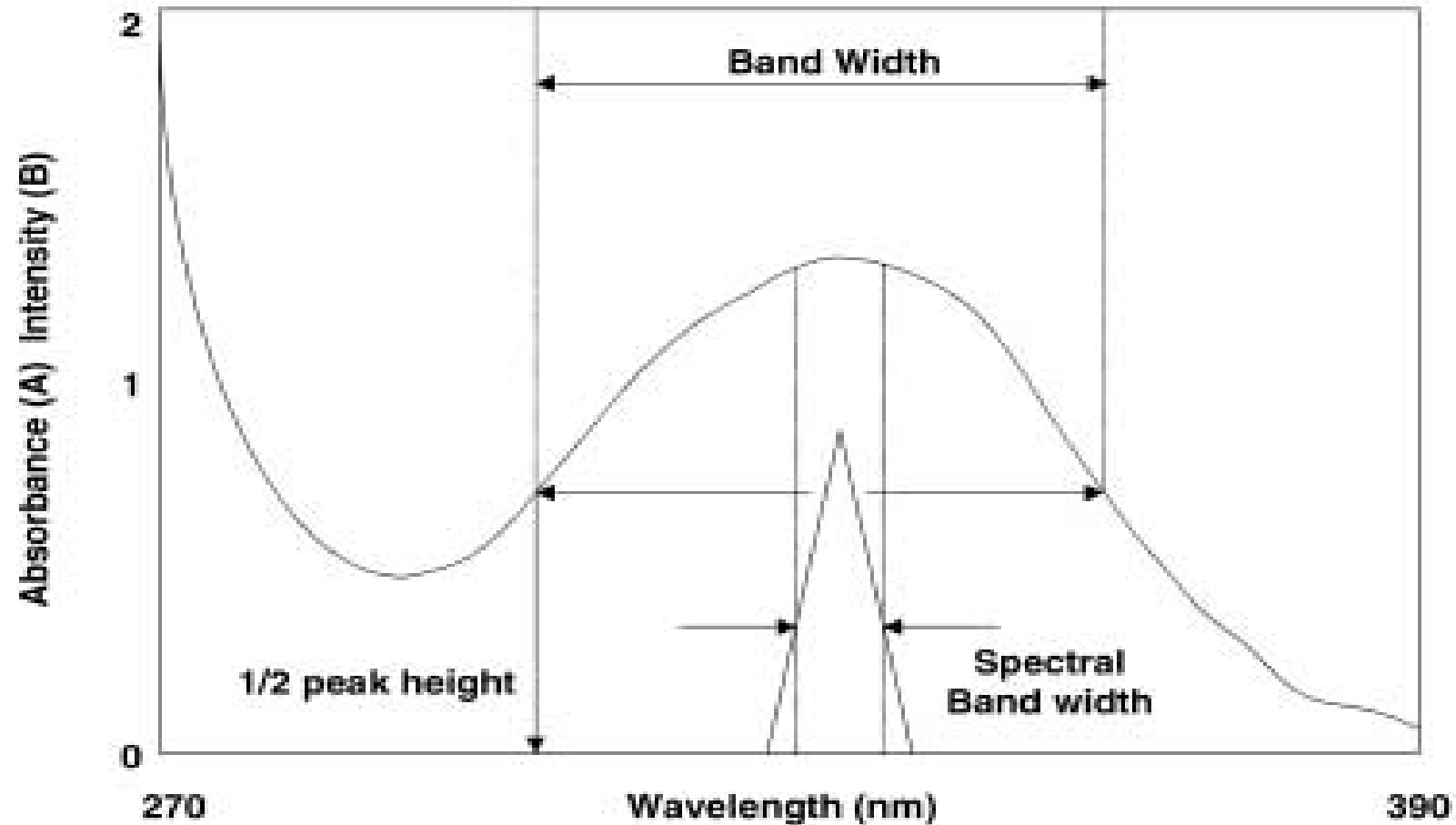

## Calibration...

- ❖ **Stray light** : stray light is defined as the detected light of any wavelength that is outside the band width of the wavelength selected .
- ✓ **Test** : Three test solutions prepared and measured the stray light at 200 nm, 220nm, 340nm
- ✓ **Acceptance** : The transmittance of the solution in a 1cm cell should be less than 0.01 or the absorbance value should be greater than 2

At 1% transmittance, stray light at 1% of the incident light intensity can cause a 15% drop in absorbance

## Stray light measurement...

| Spectral range (Nm) | Solution             | Measurement wavelength (Nm ) |
|---------------------|----------------------|------------------------------|
| 175 – 200           | Aq. Kcl (12g/L)      | 200                          |
| 210-260             | Aq .Nacl ( 10g/L)    | 220                          |
| 300-385             | Aq. NaNO*2 (50 g /L) | 340                          |

# Calibration...

## ❖ Wavelength accuracy :

It is defined as the deviation of the wavelength reading at an absorption band and emission band from the wavelength of band

## ✓ Test :

wavelength accuracy verification is checked by comparing the recorded wavelength of the peak against the value of reference standard.

## Calibration...

commonly used wavelength standards such as

- ❖ Deuterium lamp : 656.1 nm low pressure discharge lamp
- ❖ Didymium filter : 400 – 750 nm
- ❖ Holmium oxide filter : 280 -640 nm
- ❖ Solution of holmium III in perchloric acid : 240 to 640 nm

### ✓ Acceptance:

✓  $\pm 1$  nm in the UV range ( 200 to 380nm)

✓  $\pm 3$  nm in the visible range ( 380 to 800nm)

three repeated scans of the same peak should be within  $\pm 0.5$ nm.

## ❖ Noise :

Noise in the measurement affects the accuracy at both ends of the absorbance scale

Photon noise from the light sources affects the accuracy of the measurements leads to low absorbance .

## ✓ Test :

Air is scanned in the absorbance mode for 10 min .peak to noise is recorded at 500 nm. Root mean square noise is then calculated

## ✓ Acceptance : The measurement is typically less than 0.01AU



## Calibration...

### ❖ Photometric accuracy :

Photometric accuracy is determined by comparing the difference between the measured absorbance of the reference material and the established value

### ✓ Acceptance :

six replicate measurement of the 0.006% w/v of the potassium dichromate solution at 235, 257, 313 & 350 nm should be less than 0.5% RSD

### ✓ Test :

Either neutral density filters or potassium dichromate solutions are used

# Photometric accuracy...

standard value for the potassium dichromate solution

| Wavelength (nm) | Absorbance (AU) | A<br>(1%, 1CM ) | Tolerance<br>(A) |
|-----------------|-----------------|-----------------|------------------|
| 235             | 0.748           | 124.5           | 122.9-126.2      |
| 257             | 0.865           | 144             | 142.4-145.7      |
| 313             | 0.292           | 48.6            | 47.0-50.3        |
| 350             | 0.640           | 106.6           | 104.9-108.2      |

## Calibration...

### ❖ Baseline flatness:

That flat baseline test demonstrates the ability of the instrument to normalize the light intensity measurement and the spectral output at different wavelengths through out the spectral range .

### ✓ Test:

Air is scanned in the absorbance mode. The highest and lowest deflections in the absorbance unit are recorded

### ✓ Acceptance :

The deflection is typically less than 0.01 AU

## Calibration...

### ❖ Stability

The lamb intensity is a function of the age, temperature fluctuation and wavelength of the measurement these changes can lead to errors in the value of the measurements, over an extended period of time.

### ✓ Test:

Air is scanned in the absorbance mode for 60 min at specific wavelength (340nm). The highest and lowest deflection in the absorbance unit are recorded

### ✓ Acceptance :

The deflection is less than 0.002 AU/h

## Calibration...

### ❖ **Linearity:**

The linear dynamic range of the measurement is limited by stray light at high absorbance. The accuracy of the quantification of the sample depends on the precision and linearity of the measurements

### ✓ **Test:**

A series of potassium dichromate solution of concentration 20,40,60,80 and 100mg/L in 0.005M sulfuric Acid. The Absorption of various wavelength are plotted against the concentration of the solution and correlation coefficient are calculated.

### ✓ **Acceptance :** Correlation coefficient $r > 0.999$ or $r = 0.999$

# Calibration...

## SPECTRAL SLIT WIDTH

❖ When using an instrument on which the slit-width is variable at the selected wavelength, the slit-width must be small compared with the half-width of the absorption band but it must be as large as possible to obtain a high value of  $I_0$ . Therefore, a slit-width is chosen such that further reduction does not result in a change in absorbance reading.

### ❖ Method and Limits:

- Start a scan and examine the trace for a spectral peak around 656.1 nm. If no peak is seen or it is less than 50% T, increase the gain.

## Calibration...

### SPECTRAL SLIT WIDTH...

- If the signal exceeds 100% T, reduce the gain.
- Measure the width of the peak (in nanometers) at half the height of the peak.
- This represents the spectral bandwidth and should be within  $\pm 10\%$  of that selected via the computer
- Check the calibration at a slit width of 0.2 nm. If the measured slits are too small then, for a selected width, the instrument will have more photometric noise than normal. If the slit width is unacceptable, then reset the slit calibration.

# Reference

- ✓ David G. Holcombe, Michael C. Boardman, Guidance on equipment qualification of analytical instruments: UV-visible spectrophotometer, Accreditation and Quality Assurance, 6: 468 – 478, 2001.
- ✓ Chung Chow Chan, Y. C. Lee , Herman Lam, Xue-Ming Zhang, Analytical Method Validation And Instrument Performance Verification, 53 - 186, 2004.
- ✓ Qualification of Equipment guideline, Annex 3 : Qualification of UV-visible spectrophotometer, General European OMCL Network (GEON) Quality Management Document PA/PH/OMCL (19) 100 R1.
- ✓ Calibration of UV-VIS spectroscopy. Available [https://www.pharmaguidline.com/calibration\\_of\\_UV-VIS.html](https://www.pharmaguidline.com/calibration_of_UV-VIS.html) (Assessed on 2019 Feb 18)



QUALIFICATION OF  
ANALYTICAL EQUIPMENTS:  
HPTLC *and* LC- MASS SPECTROMETRY

# QUALIFICATION OF HPTLC

# PRINCIPLE

- HPTLC have similar approach and employ the same physical principles of TLC (absorption chromatography) i.e. the principle of separation is absorption .
- The mobile phase solvent flows through because of capillary action . The components move according to their affinities towards the adsorbent . The component with more affinity towards the stationary phase travels slower . The component with lesser affinity towards the stationary phase travels faster . Thus the components are separated on a chromatographic plate .

## SALIENT FEATURES OF HPTLC

- It is simple to learn and operate.
- Accuracy and precision of quantification is high.
- Samples rarely require cleanup. Low maintenance cost.

# STEPS INVOLVED IN HPTLC DEVELOPMENT

- . Selection of chromatographic layer
  - Layer pre-washing of precoated plates
  - Layer Pre-conditioning/Activation of precoated plates
  - Selection and Optimization of mobile phase
  - Sample and standard preparation
  - Application of sample and standard
  - Chromatographic development
  - Detection of spots
  - Scanning and documentation of chromo plate.

# INSTRUMENTATION

- Sample applicator
- Developing chamber
- Derivatization device
- Immersion device
- Plate heater
- Scanning densitometer
- Other accessories like:
  - (i) Plate coater
  - (ii) Drying rack
  - (iii) Plate cutter.

# A. SAMPLE APPLICATOR

- The samples are applied onto the layer as spots or bands.
- The samples are applied onto the layer as spots or bands.
- Usual concentration of applied samples 0.1 to 1  $\mu\text{g} / \mu\text{l}$  for qualitative Analysis and quantity may vary in quantitation based on UV absorption 1 to 5  $\mu\text{l}$  for spot and 10  $\mu\text{L}$  for band application.
- Precision of the applied volume, exact positioning and compactness of the application zones are important for the quality of the analysis.
- Three types of sample applicators are available:
  1. Manual
  2. Semiautomatic
  3. Automatic.

## B.DEVELOPING CHAMBER

- The "classical" flat-bottomed chamber is available in many sizes from various manufacturers.
- It has two types:-
  - 1.Twin Trough Chambers (TTC)
  2. Automatic Developing Chamber (ADC)



# 1. Twin Trough Chambers (TTC)

Twin trough chambers (TTC) (CAMAG) are among the most widely used chambers.

- They are available in sizes 10 \*10 cm, 20 \*10 cm, and 20 \*20 cm.
- Only 5 ml of solvent is required per trough for HPTLC plate in a 10 \* 10 cm chamber.

# 2. Automatic Developing Chamber (ADC)

Here there is isocratic development of HPTLC plates.

- Steps like preconditioning of layer, chamber saturation, development distance and final drying can be preset and automatically monitored independent of environmental effects.

# C. DERIVATIZATION DEVICE & IMMERSION DEVICES WITH PLATE HEATER

- Post chromatographic derivatization step.
- Substances that do not respond to visible or UV light can be rendered detectable.
- Following are types:-
  - 1. Immersion device**
  - 2. Auto reagent sprayer**
  - 3. Plate heater.**

# IMMERSION DEVICE

- The chromatogram must be immersed.
- Withdrawn at a controlled uniform speed.
- Uniform vertical speed, freely selectable between 30 mm/s and 50 mm/s.
- Immersion time selectable between 1 and 8 seconds and indefinitely.
- The device can be set to accommodate 10 cm and 20 cm plate height.
- Battery operated, independent of power supply.

## AUTO REAGENT SPRAYER

- It is a low cost alternative for HPTLC/TLC.
- It contains a rubber pump but may also be operated from a compressed air or nitrogen supply.

## Plate heater.

- The TLC Plate Heater is designed for **heating** a TLC/HPTLC plate to a *selected temperature* after a staining reagent has been applied.

## D. SCANNING DENSITOMETER

- Chromatograms are evaluated densitometrically
- The photo sensor of the densitometer measures diffusely reflected light.
- The difference between the optical signal from the sample-free background and that from a sample zone (fraction) is correlated with the amounts of the respective fractions of calibration standards chromatographed on the same plate.
- Densitometry measurements of planar chromatograms can be made by absorbance or fluorescence.

# APPLICATIONS OF HPTLC

- Herbal fingerprinting
- Herbal Analysis – Quantification
- Pharmaceutical Science
- Determination of purity of sample and Identification of compounds
- Identification of adulterants
- Forensic science
- Determination of mercury in water
- Analysis of environmental pollution levels
- Determination of  $\beta$ -blockers like Metoprolol, Alprenolol, Atenolol

## OTHER ACCESSORIES

- i. Plate coater
- ii. Drying rack
- iii. Plate cutter.

## QUALIFICATIONS (CAMAG)

- For customers working in a cGMP regulated environment, CAMAG offers Installation Qualification (IQ) and Operation Qualification (OQ) as service.

## Installation Qualification (IQ)

This qualification is performed at the site and time of installation. It documents that all key aspects of the installation comply with the manufacturer's specifications, codes, safety and design parameters. In order to qualify for an IQ Certificate, this procedure is to be performed by a Product Specialist, approved by company.



## Operation Qualification (OQ)

- This qualification is performed subsequent to installation and is repeated at certain interval recommended by the manufacturer or defined by the customer. It documents that all modules of the equipment perform consistently throughout the specified operating ranges.
- The initial OQ is performed by the person responsible for the IQ at installation. In order to qualify for an OQ Certificate, this procedure is to be performed by a Product Specialist, approved by company.

## Operation Qualification (OQ)...

- Repetitive OQ's can be performed by a system user well acquainted with the system, following guidelines issued by company. On request of the customer, such OQ's can be performed by a Product Specialist or Service Engineer approved by company, against a fee or within a service contract.

## Performance Qualification (PQ)

- PQ is performed to ascertain that the instrument (system) is suitable to perform a specific analytical task as part of the manufacturing process.

## PQ...

- PQ is an on-going task with the customers samples and procedures including preventive maintenance and regular tests, such as system suitability and quality control analyses with creation of QC-charts. For computer systems it also includes regular data backup, virus checks and change control procedures.
- PQ can thus only be performed by the user himself who also has to create the SOP's based on the analytical task, the company OQ procedure, the different instrument manuals and the customer's QC requirements.

# Design Qualification (DQ)

- This qualification verifies that the rigorous specifications and design review methods defined in the Quality Management System of the manufacturer have been followed.
- Quality Management System ascertains planned testing procedures, error reporting and controlled updating of documents. Compliance is documented, e.g. by the "Declaration of System Validation" and "Declaration of Conformity" supplied with specific products.
- The Design Qualification is sometimes used in a different meaning. One common misunderstanding is to use DQ for "suitability of the laboratory equipment". To make sure the laboratory is equipped with the necessary supporting equipment etc.,

# QUALIFICATION OF LC-MS

# LIQUID CHROMATOGRAPHY MASS SPECTROMETRY

- Liquid chromatography-mass spectrometry (LC/MS) is a technique that uses liquid chromatography (HPLC) with the mass spectrometry.
- It is an analytical chemistry technique that combines the physical separation capabilities of liquid chromatography with the mass analysis capabilities of mass spectrometry.

# PRINCIPLE

•The LC-MS technology involves use of an HPLC, wherein individual components in a mixture are first separated followed by ionization and separation of the ions on the basis of their mass/charge ratio. The separated ions are then directed to a photo multiplier tube detector, which identifies and quantifies each ion. The ion source is an important component in any MS analysis, as this basically aids in efficient generation of ions for analysis. To ionize intact molecules, the ion source could be APCI (Atmospheric Pressure Chemical Ionization), ESI (Electrospray Ionization), etc. to name a few popular ones. The choice of ion source also depends on the chemical nature of the analyte of interest i.e. polar or nonpolar.

# Instrumentation of LCMS

HPLC system

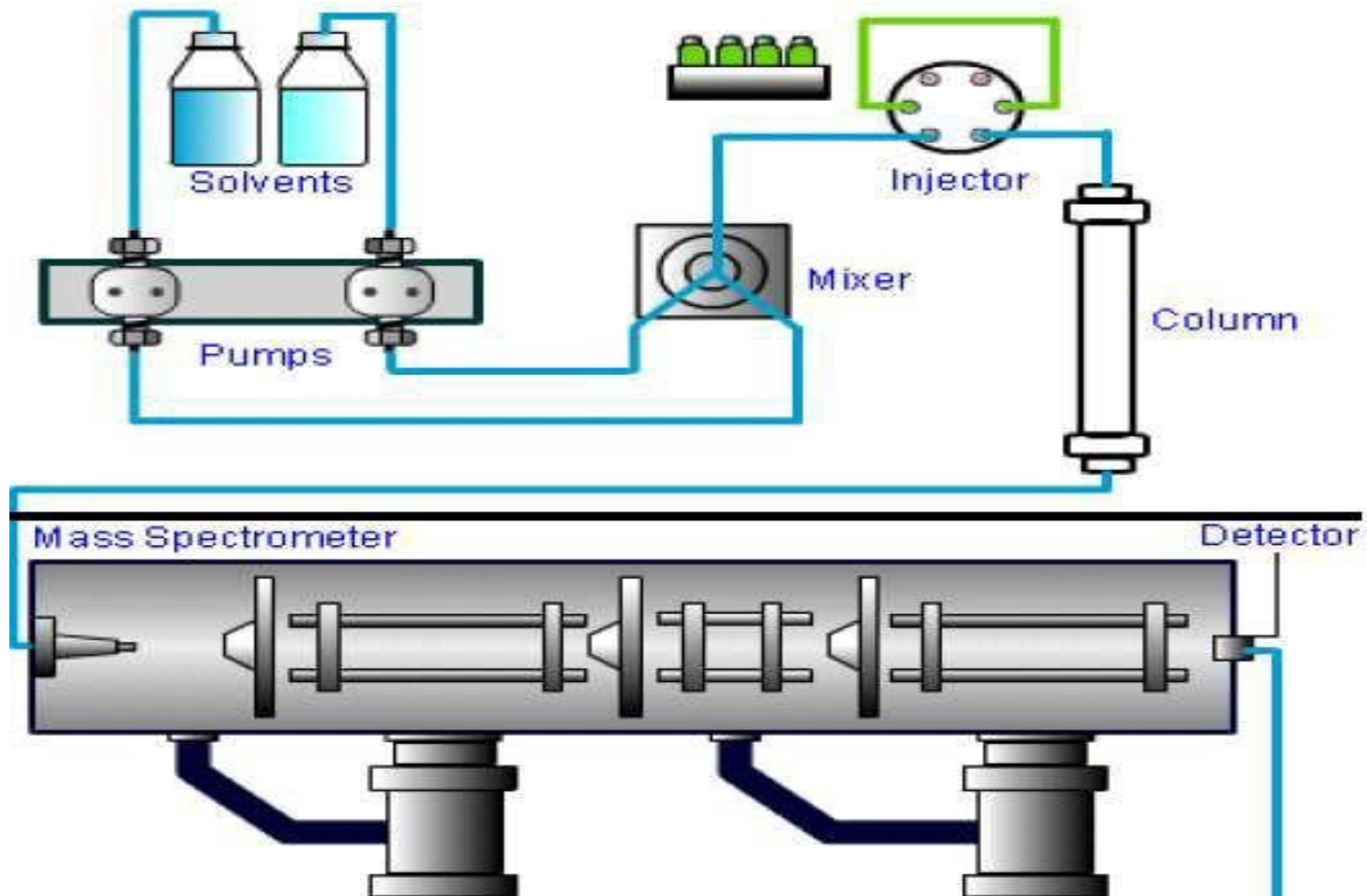



# Components of Mass Spectrometer :

**1. Ion source**, which can convert gas phase sample molecules into ions.

Following are the most common ionization methods :

- i. Electrospray Ionization
- ii. Atmospheric Pressure Chemical Ionization
- iii. Atmospheric Pressure Photo-ionisation

# Components of Mass Spectrometer :

**2. Analyzer**, where ions are separated according to their mass-to-charge ratio by applying electromagnetic fields.

- Its task is to separate ions in terms of their mass-to charge
- Ratio and to direct the beam of focused ions to the detector.
- The key performance parameters of an analyzer include;
  - (a) separation efficiency
  - (b)  $m/z$  measurement precision
  - (c) range of the  $m/z$  values measured
- There are following kinds of mass analyzers that can be used in LC/MS :
  - (a) Quadrupole Analyzer,
  - (b) Time-of-Flight Analyzer,
  - (c) Ion Trap Analyzer

# Components of Mass Spectrometer :

## **3. Detectors :**

The detector is used to count the ions emergent from the mass analyzer, and may also amplify the signal generated from each ion.

Following are three different kinds of detectors are used in Mass Spectrometry;

- (a) Electron Multipliers
- (b) Dynolyte Photomultiplier

# Tandem Mass Spectrometry

- Tandem mass spectrometry (MS/MS) is a system of two combined analyzers of the same type or different types, characterized by high separation efficiency.
- The ions produced by the source are separated in the first analyzer (MS1). Ions with the selected  $m/z$  value reach the collision cell where, depending on the analysis conditions, they undergo dissociation or remain unchanged.
- In comparison with analysis using a single analyzer, tandem analysis shows a considerable improvement in selectivity and considerably increased sensitivity.

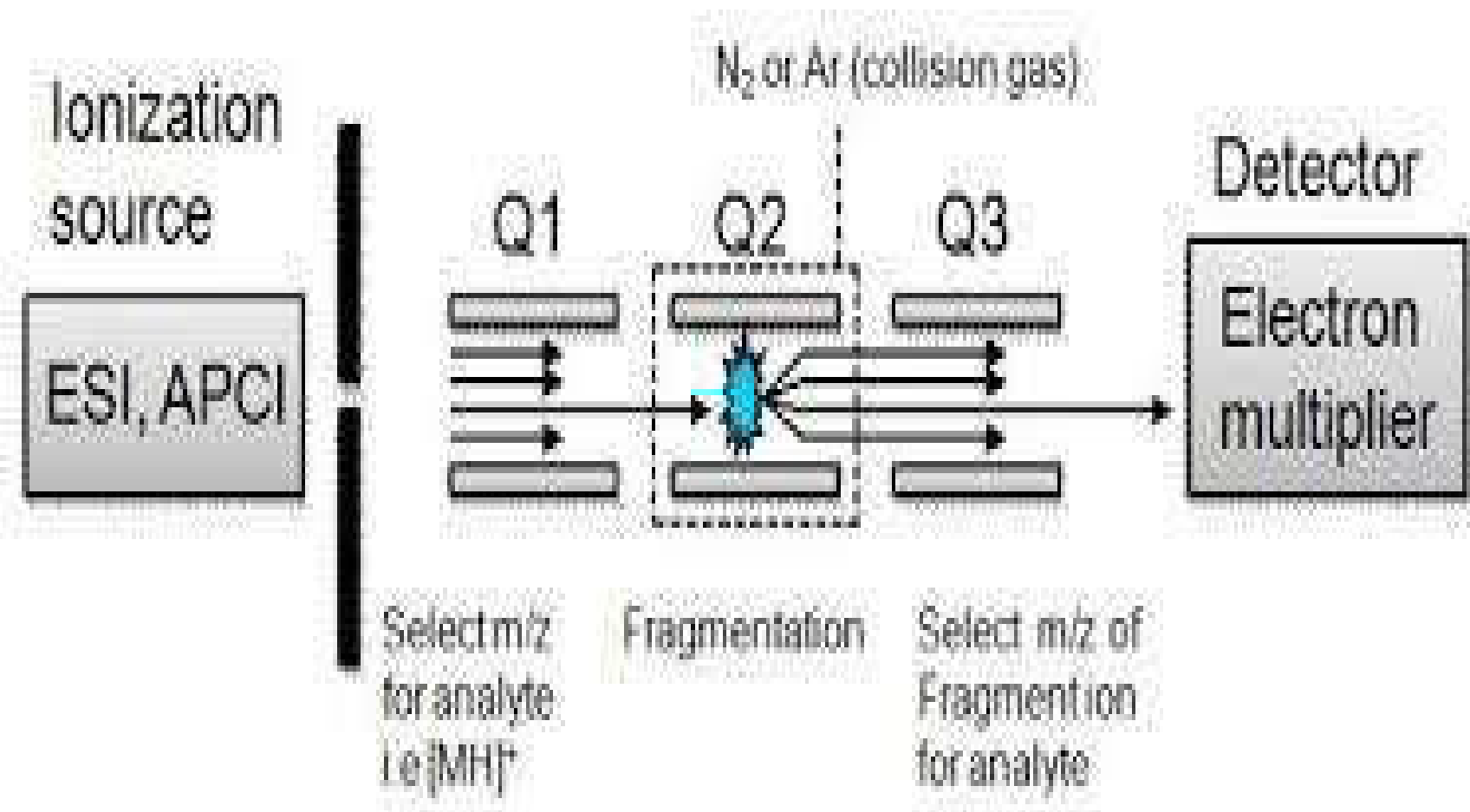

# OQ—Operational Qualification

- Temperature accuracy and stability of column heater/cooler
- Holmium oxide wavelength scan (if applicable)
- Detector lamp intensity and wavelength accuracy
- Detector noise and drift
- Pump flow rate accuracy and repeatability
- High and low pressure shutdown accuracy
- Injector precision
- Detector linearity and sample to-sample carryover
- Injection volume linearity
- Gradient composition accuracy
- Linear gradient tested using IPA and 0.5% Acetone/IPA
- Five step gradient tested using IPA and 0.5% Acetone/IPA

## **IQ—Installation Qualification**

- Inventory of instruction manuals,
- components and serial numbers
- Installation verification

## **IQ—Installation Qualification**

- Inventory of instruction manuals,
- components and serial numbers
- Installation verification

# Tests for HPLC Systems (Non-MSD)

| Test Name           | Setpoints and Parameters                                      | Limits  |
|---------------------|---|---|
| Vacuum Verification | N/A   | High vacuum min.: 8E-6 torr (any source)<br>High vacuum max.: 4E-5 torr (any source),     |
| Scan Verification   |   | All used masses: — 3.0 ppm (DSES, ES+AJST; N/A for others)                                |
| Response Linearity  | Evaluated mass: 156 m/z<br>Injection volume on column: 20 ul* | Coefficient of determination (r <sup>2</sup> ): ≥ 0.98000 (DSES, ES+AJST; N/A for others) |



# Tests for HPLC Systems (Non-MSD)

| Test Name            | Setpoints and Parameters   | Limits   |
|----------------------|--|--|
| Injection Precision  | Evaluated mass: 156 m/z<br>Injection volume on column: 20 $\mu$ l* | Area RSD: $\leq 20.00\%$ (any source)<br>Height RSD: Not applicable (any source) |
| Injection Carry Over | Evaluated mass: 156 m/z<br>Injection volume on column: 20 $\mu$ l* | Area & height carry over $\leq 1.00\%$<br>(DSES, ES+AJST; N/A for others)        |
| Signal to Noise      | Evaluated mass: 156 m/z<br>Injection volume on column: 20 $\mu$ l* | Signal to noise: $\geq 10$ (DSES, ES+AJST; N/A for others)                       |

# Tests for Mass Spectrometer Detectors of LCMS:

## **MSD 1. Vacuum Verification**

Rationale: A stable, high vacuum is required for high-sensitivity mass spectrometry.

Procedure: Multiple readings of the vacuum system are taken and an automated comparison of these values to the known acceptable values is made. Passing this test is a prerequisite for the following tests.

## **MSD 2. Scan Verification**

Rationale: Calibration of mass range is critical in qualitative mass spectrometry.

## MSD 2. Scan Verification...

Procedure: [Agilent LCMS] The built-in Agilent autotune is performed to determine the proper calibration of the MSD and ensure that masses are correctly reported across the entire mass range of the instrument. [Non- Agilent LCMS] A manual tune is made where applicable.

## MSD 3. Response Linearity

Rationale: Knowledge of the response curve is critical for quantitative analysis. Procedure: A sulfa drug mix standard of four sulfonamide drugs is injected into the system at five concentrations representing a wide range for LCMS.

The ions monitored are appropriate to the system type. The calculated RSQ best-fit regression line and plot of the response curve provides the statistics required to evaluate the instrument's overall response curve. This allows users to set appropriate calibration ranges and limits in their quantitative application methods.

## MSD 4. Injection Precision

Rationale: System precision is critical for accuracy of quantitation. Autosampler performance and MS ionization contribute to LCMS system precision. Autosampler precision is challenged in the standard LC module tests using a UV detector. A repeat precision test in MS mode further challenges the precision of source ionization and MS detection. Procedure: A blank injection followed by six repeat injections of the sulfa drug mix followed by a final blank injection are made. The %RSD of the six injections is calculated to provide precision statistics.

## MSD 5. Carry Over

Rationale: Low carry over from a previous injection is critical for accuracy of quantitative and reliability of qualitative analysis. Autosampler performance and MSD condition contribute to LCMS carry over. Autosampler carry over is challenged in the standard LC module tests using a UV detector.

## **MSD 5. Carry Over**

A repeat carry over test in MS mode further challenges the full LCMS system carry over performance.

Procedure: A blank injection followed by single injection of the highest concentration standard followed by a blank injection. The last blank injection is evaluated for carry over and the result expressed as a percentage of the value for the standard injection.

## **MSD 6. Signal to Noise**

Rationale: Sensitivity of MS detection is an important performance feature in quantitative and qualitative analysis. A signal-to-noise value of representative compounds and appropriate ions at known concentration provides sensitivity statistics.

# Reference

- <https://www.slideshare.net/ankush96/qualification-of-hptlc>
- <https://www.slideshare.net/ankush96/qualification-of-lcms>
- [https://sciex.com/Documents/service/LCMS\\_Performance\\_Qualification\\_svc.pdf](https://sciex.com/Documents/service/LCMS_Performance_Qualification_svc.pdf)

# QUALIFICATION OF HPLC

# QUALIFICATION OF HPLC

- **INTRODUCTION**

- Equipment qualification is a formal process that provides documented evidence that an instrument is fit for its intended use and kept in a state of maintenance and calibration consistent with its use .
- Schedule M states about the qualification of the equipment  
**The qualification process consists of four**
  - **parts:**
    - **Design qualification (DQ)**
    - **Installation qualification (IQ)**
    - **Operational qualification (OQ)**
    - **Performance qualification (PQ)**



# DESIGN QUALIFICATION

- Design qualification (DQ) describes the user requirements and defines the functional and operational specifications of the instrument.
- It should ensure that instruments to be purchased have the necessary functions and performance that will enable them be suitable for the intended applications.
- The DQ document will be used as a basis for tests in the OQ phase.
- Lists elements with examples that should be included in the design qualification for the HPLC systems in the selected QA/QC laboratory.
- Please note that all instruments are required to have gradient pumps, thermostatted column compartments and diode-array detectors to ensure that they all can be used for all applications.

# Qualification of High-Performance Liquid Chromatography Systems

| Design elements  | Examples  |
|--|---|
| <p data-bbox="428 575 766 625">Intended use</p> <p data-bbox="428 718 1217 911">User requirement specification for the HPLC analysis</p> | <p data-bbox="1263 575 2033 696">Analysis of drug compounds and impurities</p> <ul data-bbox="1263 718 2071 1382" style="list-style-type: none"><li data-bbox="1263 718 1867 768">• Up to 100 samples / day</li><li data-bbox="1263 789 2020 839">• Automated over-night analysis</li><li data-bbox="1263 861 1939 911">• Limit of quantitation: 0.1%</li><li data-bbox="1263 932 2071 1382">• Automated confirmation of peak identity and purity with diode-array detection</li><li data-bbox="1263 1203 1824 1382">• Automated compound quantitation and printing of report</li></ul> |

# Qualification of High-Performance Liquid Chromatography Systems...

- Functional specification

|                    |   |
|--------------------|---|
| pump               | Binary or higher gradient   |
| Detector           | UV/Vis Diode-array, 190-900 nm  |
| Autosampler        | 100 samples, 0.5 ul to 5 ml sample volume   |
| Column compartment | 15 to 60 Deg C, peltier controlled  |
| computer           | System control, data acquisition for signals and spectra, peak integration and quantitation spectral evaluation for peak purity and compound confirmation .Electronically save all chromatograms generated by the system. |

# Qualification of High-Performance Liquid Chromatography Systems...

## **Operational specifications**

Detector: Baseline noise:  $<5 \times 10^{-5}$  AU

- Sampler: Precision inj. volume:  $<0.5\%$  RSD, sample carry over:  $<0.5\%$
- Pump: precision of retent.time:  $<0.5\%$  RSD

## **User instructions**

- Operational manual on paper
- Computer based tutorial

# Qualification of High-Performance Liquid Chromatography Systems...

- **Validation/qualification**
- Vendor must provide procedures and services for IQ and OQ
- **Maintenance**
- Vendor must deliver maintenance procedure and recommend schedule
- Instrument must include early maintenance feedback for timely exchange of most important maintenance parts
- Maintenance procedures must be supplied on Multimedia CD ROM
- **Training**
- Vendor must provide familiarization and training

# Installation qualification

- Installation qualification establishes that the instrument is received as designed and specified, that it is properly installed in the selected environment, and that this environment is suitable for the operation and use of the instrument.
- Steps as recommended before and during installation.
- IQ should include analysis of a tests ample.
- A successful run of such a sample verifies correct installation of all modules and electrical and fluid connections
- There are two installation qualification they are before and during installation qualifications .

# Installation qualification...

- **Before installations**
- Obtain manufacturer's recommendations for installation site requirements.
- Check the site for the fulfillment of the manufacturer's recommendations (utilities such as electricity, and environmental conditions such as humidity and temperature).
- Allow sufficient shelf space for the equipment, SOPs, operating manuals and software.

# Installation qualification...

- **During installation**
- **Compare equipment, as received, with purchase order (including software, accessories, spare parts)**
- **Check documentation for completeness (operating manuals, maintenance instructions, standard operating procedures for testing, safety and validation certificates)**
- **Check equipment for any damage**
- **Install hardware (computer, equipment, fittings and tubings for fluid connections, columns in HPLC and GC, power cables, data flow and instrument control cables)**



# Installation qualification...

- Switch on the instruments and ensure that all modules power up and perform an electronic self test
- Identify and make a list with a description of all hardware, include drawings where appropriate .
- Run test sample and compare chromatogram print-out with reference chromatogram
- List equipment manuals and SOPs
- Prepare an installation report

# OPERATIONAL QUALIFICATION

- Operational qualification ( OQ ) is the process of demonstrating that an instrument will function according to its operational specification in the selected environment
- It verifies that the HPLC systems complies with key functional and operational requirements as specified in the design qualification

# PERFORMANCE QUALIFICATION

- The performance qualification (PQ) is to verify the functions of the systems according to its design specifications and documents
- OQ involves the verification of working standards of the system
- Thus the HPLC system was qualified and released for use

# OQ AND PQ

- Operational qualification involves verifying that the 996 or 2996 Photo Diode
- Array Detector meets operational standards for: Startup diagnostics, Wavelength accuracy and linear response to analyte concentration.
- During performance qualification, the equipment is operated with load and all the process parameters and process deliverables are recorded.

# OO AND PQ...

- **MATERIALS AND METHODS**
- **MATERIALS**
- HPLC (Waters, Model- 2690 & 2695, ID- AIZ/AD/083).
- **METHODS**
- The various tests are to be carried out to define the
- Wavelength accuracy
- Detector linearity and
- Separation module of the analytes.
- The various tests carried out for the operational qualification are briefly summarize below.

# OO AND PQ...

## **Wavelength Accuracy Test**

Chromatographic conditions :

|                  |                                |
|------------------|--------------------------------|
| Column           | : C18, 4.6 x 150mm, 5 $\mu$ m  |
| Flow rate        | : 1.0 mL / min                 |
| Detector         | : UV at 273 nm                 |
| Mobile phase     | : Water: Methanol (70:30% v/v) |
| Injection volume | : 20 $\mu$ L                   |
| Oven temperature | : 40°C                         |
| Run time         | : 6 min                        |
| Retention time   | : 3.0 min (approx.)            |

# OQ AND PQ...

## **Wavelength Accuracy test procedure and acceptance criteria**

**Procedure:** Created the methods for different wavelengths ranging from 201-209 nm & 271-277 nm in the above conditions and injected caffeine 25 µg /mL solution.

### **Acceptance criteria:**

$\lambda_{\max}$  should be in the range of  $205 \pm 2$  nm,  $273 \pm 2$  nm and  $\lambda_{\min}$  should be  $245 \pm 2$  nm.

# OO AND PQ...

## **Detector Linearity**

### **Chromatographic conditions used:**

Column : C18, 4.6 x 150 mm, 5 $\mu$ m

Flow rate : 1.0 mL / min

Detector : UV at 273 nm

Mobile Phase : Water: Methanol (70:30% v/v)

Oven temperature : 40 $^{\circ}$ C

Injection volume : 20  $\mu$ L

Run Time : 6 min

Diluent : Water

Retention time : 3.0 min (approx.)



# OQ AND PQ...

## **Detector Linearity test procedure and limit**

### **Preparation of linearity solutions of caffeine:**

**Preparation of Stock solution:** Weighed accurately 10 mg of caffeine and transferred into a 20 ml volumetric flask, dissolved in few ml of water and diluted up to the mark with water. (Conc.: 0.5 mg / mL).

**Preparation of working solution:** Pipetted out 10 mL of stock solution of caffeine into 100 mL volumetric flask and made up the volume with water. (Conc.: 50 µg / mL).

# OQ AND PQ...

## **Detector Linearity test procedure and limit....**

From the working solution, concentration like 0.5µg/ml, 1.0µg/ml, 5.0µg/ml, 10µg/ml, 25µg/ml and 50µg/ml were prepared in 100ml volumetric flask and the volume was made up with the diluent.

**Procedure:** Injected 20 µL blank followed by each of the diluted range of linearity solutions and noted the area of the peak. Plotted the linearity curve from the software using calibration options and calculated the squared correlation coefficient.

**Limit:** Squared correlation coefficient,  $r^2$  should be 0.999.

# OQ AND PQ...

**Separation module:** The efficacy of separation process of the analytes following procedures were carried out.

**Flow rate accuracy:**

- Removed the column and put all the channels in the reservoir of water. Purged all pumps and connected resistance capillary tube in the place of column, then flushed the system for stabilization with pumps A-25%, B-25%, C-25% and D-25% at flow of 1.0 mL / min for 15 to 30 minutes. Entered the desired flow rate in the flow rate field in the status screen, and then
- pressed <Enter Tab> from the Display control.

# OQ AND PQ...

## **FLOW RATE ACCURACY.....**

When the flow and pressure were stable, simultaneously inserted the column inlet tubing in to a 10 ml 'A' grade volumetric flask (dried and weighed previously, W1) and started the stopwatch.

Stop the stopwatch when water reached the lower meniscus in 10 ml flask and

weighed the flask with water (W2).

Calculated the flow rate using the following equation.

$$\text{Flow rate delivered by the pump (in ml / minute)} = \frac{(W2 - W1) \times 60 \times \text{'Z' factor of water}}{\text{Time in seconds}}$$

# OQ AND PQ...

## **FLOW RATE ACCURACY ACCEPTANCE CRITERIA**

Performed the above procedure for flow rates of 0.5 ml/ min, 1.0 ml/ min, 1.5 ml/ min and 2.0 ml/ min.

Acceptance criteria of the flow rate accuracy test for 0.5 to 2.00 ml/min should be in the range of  $\pm 2.0\%$ .

# OO AND PQ...

**Gradient accuracy test (GPV): Chromatographic**

**Conditions used were:**

**Flow rate :** 2.0 ml/ minute

**Detector :** UV at 265 nm

**Run time :** 30 minutes

**Procedure:**

- Setup the column oven temperature to 40°C. Placed the A and C channels in HPLC water and the B and D channels in 0.5% v/v Acetone (5 ml of Acetone in 1 Liter of water).
- Purged all pumps and stabilized the system with the above chromatographic conditions for 15 to 30 minutes.

# OQ AND PQ ...

## **Gradient accuracy test (GPV) .....**

Injected 0 µL of water and recorded the gradient profile.

Calculated the concentration at 10% (10.00 min), 50% (15.00 min) and 90% (20.00 min) levels using the following formula.

(Height at 10% – Height at 0%)

Actual concentration of 10% = ----- × 100

(Height at 100% – Height at 0%)

**Acceptance criterion:** ±1.0% to the set value.

Gradient programme for channel A, B & C, D is defined in table .

# OO AND PQ ...

**Table : Gradient programme for Channel A, B & C, D.**

| <b>Time<br/>(min)</b> | <b>Gradient programme for<br/>Channel A &amp; B</b> | <b>Gradient programme for<br/>Channel C &amp; D</b> |
|-----------------------|---|---|
| <b>Initial</b>        | <b>100 0.0</b>                                      | <b>100 0.0</b>                                      |
| <b>5.00</b>           | <b>100 0.0</b>                                      | <b>100 0.0</b>                                      |
| <b>5.01</b>           | <b>90 10</b>  | <b>90 10</b>  |
| <b>10.00</b>          | <b>90 10</b>  | <b>90 10</b>  |
| <b>10.01</b>          | <b>50 50</b>  | <b>50 50</b>  |
| <b>15.00</b>          | <b>50 50</b>  | <b>50 50</b>  |
| <b>15.01</b>          | <b>10 90</b>  | <b>10 90</b>  |
| <b>20.00</b>          | <b>10 90</b>  | <b>10 90</b>  |
| <b>20.01</b>          | <b>0.0 100</b>                                      | <b>0.0 100</b>                                      |
| <b>25.00</b>          | <b>0.0 100</b>                                      | <b>0.0 100</b>                                      |
| <b>25.01</b>          | <b>100 0.0</b>                                      | <b>100 0.0</b>                                      |
| <b>30.00</b>          | <b>100 0.0</b>                                      | <b>100 0.0</b>                                      |



# OO AND PQ ...

## **Temperature Accuracy:**

### **Procedure:**

- Temperature stability of column compartment Set the column oven temperature to 40°C and stabilized for about half an Hour.
- Kept the probe of calibrated digital thermometer inside the oven at left corner and allowed to stabilize.
- After stabilization, temperatures were noted down.
- The steps were repeated by placing the probe of digital thermometer inside the oven at right corner.
- The above procedure was repeated with 80°C and 25°C also.

# OQ AND PQ ...

## **Temperature Accuracy:**

**Acceptance criteria:** The result should be  $40^{\circ}\text{C} \pm 2^{\circ}\text{C}$ ,  $80^{\circ}\text{C} \pm 3^{\circ}\text{C}$ , and  $25^{\circ}\text{C} \pm 1^{\circ}\text{C}$ .

## **Temperature stability of sample compartment:**

Set the thermostat to  $4.0^{\circ}\text{C}$  and placed the probe of calibrated digital thermometer in one location of auto sampler and allowed the temperature to stabilize and recorded the reading .

The above steps were repeated for any subsequent locations.

**Acceptance criterion:** The observed temperature should be within  $\pm 0.5^{\circ}\text{C}$  to the set value

# OQ AND PQ ...

## **Vial identification test (carousel test):**

- Took 5 empty fresh vials (with new septa) and placed randomly at different vial locations. Set the system to draw lowest injection volume from each vial(0  $\mu$ L).
- Took out each vial from the instrument and checked for septum piercing.

**Acceptance criterion:** All the vials septa should be pierced.

# OQ AND PQ ...

## **System Performance Qualification Tests:**

Before this startup procedure, ensured that each instrument in the HPLC system passed its operational qualification tests.

**To prepare the HPLC system for performance qualification tests:**

- 1.Ensured that the system was prepared with filtered degassed mobile phase.
- 2.Installed the column as described in the applicable documentation.
- 3.Power-on all chromatographic instruments according to the instructions in the applicable documentation.
4. Allowed 30 minutes for the detector to stabilize

# OO AND PQ ...

**Injector Precision:**

**Chromatographic Conditions Used:**

**Column :** C18, 4.6 x 150 mm, 5 $\mu$ m

**Flow rate :** 1.0 mL / min

**Detector :** UV at 273 nm

**Mobile Phase :** Water: Methanol (70:30% v/v)

**Oven temperature :** 40°C

**Injection volume :** 20  $\mu$ L

**Run Time :** 6 min

**Diluent :** Water

**Retention time :** 3.0 min (approx.)

# OQ AND PQ ...

## **Injector precision**

### **Procedure:**

- Injected a blank solution (water) followed by 6 replicate injections of 25 µg / mL solution of caffeine into the equilibrated HPLC system.
- After completion of runs, the Relative standard deviation (RSD) for area and height of caffeine peak were calculated.

### **Acceptance criteria:**

RSD for the retention time of caffeine in six injections should be ≤ 1.0%. RSD for the peak area of caffeine in six injections should be ≤ 1.0 %. RSD for the peak height of caffeine in six injections should be NMT 2.0%

# OQ AND PQ ...

## **Injector Linearity**

**Chromatographic conditions were as same as described in Injector precision.**

### **Procedure:**

- Injected caffeine 25  $\mu\text{g}$  / mL solution at linear injection volumes such as 5  $\mu\text{L}$ , 10  $\mu\text{L}$ , 20  $\mu\text{L}$ , 40  $\mu\text{L}$ , 50  $\mu\text{L}$  and 100  $\mu\text{L}$  in the set chromatographic conditions.
- Plotted the linearity curve from the software using calibration options and calculated the squared correlation coefficient.

**Limit:** Squared correlation coefficient,  $r^2$  should be  $\geq 0.999$ .

# QUALIFICATION OF GC...

## **INTRODUCTION :**

Demonstrate that equipment used in validation studies is suitable for use and is comparable to equipment used for routine analysis

Qualifications should have been performed

- Installation Qualification
- Operation Qualification
- Performance Qualification

## **Installation Qualification (I.Q)**

The purpose of I.Q is to check the installation site/environment, confirms

equipment specifications and verifies the condition of installed equipment



# QUALIFICATION OF GC...

## **I.Q protocol shall include the following:**

- Confirmation of the specifications of the analytical equipment.
- Confirmation and maintenance of documents (Instruction manuals, qualification protocol and certificates).
- Confirmation of installation site and conditions
- Confirmation of delivered equipment.
- Confirmations of Software and firmware i.e., verify that the equipment is consistent with actual versions displayed when power is turned on.

In I.Q, connect each unit (Electrical system, Flow line system) and confirm that the connections are correct. Any problems identified in I.Q must be investigated and appropriate actions must be taken. All such actions must be documented and approved by higher authority.

# QUALIFICATION OF GC...

## **Operational Qualification (O.Q):**

- O.Q includes procedures and documentation of O.Q of analytical instrument.
- When all procedures are executed and all items pass the inspection, it is verified that the system operates to satisfy the intended purpose.

## **O.Q protocol :**

Operation check on each unit

- Due to modular nature of the system, the operation of each unit is checked properly.

Operation check on overall system

- Confirm that the system controller and work station control each unit during analysis and that the analysis results meet the prescribed criteria.

# QUALIFICATION OF GC...

## **O.Q protocol .....**

- **Software and Firmware check**

- Here Firmware checking is conducted based on version display and Software certificate of Compliance.
- The Software and Firmware must be properly managed and change procedures must be properly clarified.
- Any problems identified in O.Q must be investigated and appropriate actions must be taken. All such actions must be documented and approved by higher authority. Prior to implementing O.Q, check the system configuration, determine the items to be evaluated and record them in O.Q record and have them approved.

# QUALIFICATION OF GC...

## **Performance Qualification (PQ):**

- The objective is to ensure that the instrument is performing within specified limits.
- Hence documented verification that the equipment and ancillary systems, as connected together, can perform effectively and reproducibly based on the approved
- process method and specifications.
- The PQ represents the final qualification of equipment or system. This incorporates a range of testing to simulate your production
- process options and provide assurance that systems and operating documentation are capable of subsequent process validation activities.

# QUALIFICATION OF GC...

## **Performance Qualification (PQ).....**

It is used to establish and or confirm;

1. Definition of performance criteria and test procedures.
2. Selection of critical parameters, with predefined specifications.
3. Determination of the test intervals, e.g.,
  - (a) - Everyday.
  - (b) - Every time the system is used.
  - (c) - Before, between and after a series of runs.
4. Define corrective actions on what to do if the system does not meet the established criteria.

# QUALIFICATION OF GC...

**Various qualification parameters are:**

- Flow rate accuracy
- Column oven temperature accuracy
- System precision
- System precision for head space auto sampler
- Detector linearity
- Detector noise and drift test

# QUALIFICATION OF GC...

## **Flow rate accuracy:**

1. Connect the digital flow meter to the detector outlet port.
2. Set the carrier gas (Helium) flow and wait till it reaches the set flow.
3. Note the observed flow in replicate.
4. Repeat the procedure for other carrier gases such as Hydrogen and Air.
5. Record the result in GC calibration protocol.

# QUALIFICATION OF GC...

## **Flow rate accuracy.....**

**Acceptance criteria:** The flow rate of carrier gas should be  $\pm 10\%$  of set flow.

## **Flow Rate Accuracy:**

| <b>S.No.</b> | <b>Carrier gas</b> | <b>acceptance criteria ml/m</b> |
|--------------|--------------------|---------------------------------|
| 1.           | Helium             | 125                             |
| 2.           | Hydrogen           | 40                              |
| 3.           | Air                | 400                             |



# QUALIFICATION OF GC...

## **Column Oven Temperature Accuracy:**

1. Connect the column to the detector port.
2. Place the thermometer probe in the column oven and set the column oven temperature at 40°C. Wait till the temperature stabilizes.
3. Note the observed temperature as read by the probe in triplicate over a period of 10m.
4. Repeat the procedure for 100°C, 150°C and 190°C.

## **Acceptance criteria:**

The resulting oven temperature from the thermometer display should be within  $\pm 2^\circ\text{C}$  of the set temperature

# QUALIFICATION OF GC...

**System Precision:**

**Preparation of Standard solution:**

Transfer 20 ml of Methanol, Ethanol and Acetone into 100ml volumetric flask and make up with Ethyl acetate

**Procedure:** Inject blank, followed by Standard preparation in 6 replicates.

Note down the areas and Retention times.

**Acceptance criteria:** The %RSD of retention time should be not more than 1.0% & peak area should be not more than 5.0%.

# QUALIFICATION OF GC...

## **System Precision:**

Chromatographic Conditions for System Precision

Column 30m × 0.32mm, 1.8μ, DB-624

Detector Flame ionization detector

Injector temperature 180°C

Detector temperature 250°C

Flow mode Pressure

Carrier Gas flow rate Helium 25 kpa

Oven program 50°C(hold 5 m) raise to 10°C

Split ratio 1:10

Injection volume 0.2 μl

Hydrogen flow 40 ml/m

Air flow 400 ml/m

# QUALIFICATION OF GC...

**System precision for head space autosampler:**

**Preparation of standard solution:** Prepare a standard mixture solution by taking Methylene dichloride (0.6g), Chloroform (0.06g), Trichloroethane (0.08g), 1,4-Dioxane (0.38g) in 50ml volumetric flask containing about 40ml of Dimethyl formamide. Finally makeup to volume with DMF (Solution-A).

# QUALIFICATION OF GC...

**System precision for head space autosampler:.....**

**Procedure:**

- Take 0.5 ml of standard solution-A in 6 different vials and seal with septum, then magnetic caps and crimp.
- Place these vials on head space sampler; prepare a blank vial also. Load the vials in head space sampler tray. Blank vials followed by the standard vials.

**Acceptance criteria:** The %RSD of retention time should be NMT 1.0% & peak area should be NMT 15.0%.

# QUALIFICATION OF GC...

## **Chromatographic Conditions For Head Space Auto Sampler**

Column 30m × 0.32mm, 1.8μ, DB-624

Detector Flame ionization detector

Injector temperature 220°C

Detector temperature 260°C

Flow mode Pressure

Carrier Gas flow rate Helium 25 kpa

Oven program 40°C(hold 5 m) raise to 200°C(hold 5 m)

Split ratio 1:10

Injection volume 0.2 μl

Hydrogen flow 40 ml/m

Air flow 400 ml/m

# QUALIFICATION OF GC...

## **Head Space Conditions**

Vial equilibrium 22 m

Vial pressure 0.5 m

Loop fill 0.5 m

Loop equilibrium 0.05 m

Inject 1.00 m

GC cycle time 38 m

Oven temperature 80°C

Loop temperature 100°C

Vial pressure 10.8 psi

# QUALIFICATION OF GC...

## **Head Space Conditions**

Vial equilibrium 22 m

Vial pressure 0.5 m

Loop fill 0.5 m

Loop equilibrium 0.05 m

Inject 1.00 m

GC cycle time 38 m

Oven temperature 80°C

Loop temperature 100°C

Vial pressure 10.8 psi



# QUALIFICATION OF GC...

**Detector linearity:**

**Preparation of standard solutions:**

**☐ Detector linearity solution A:**

Transfer 10ml of each Methanol, Ethanol and Acetone into a 100ml volumetric flask and dilute to the volume with Ethyl acetate.

**☐ Detector linearity solution B:**

Transfer 15ml of each Methanol, Ethanol and Acetone into a 100ml volumetric flask and dilute to the volume with Ethyl acetate.

# QUALIFICATION OF GC...

**Detector linearity:**

**Preparation of standard solutions.....**

**Detector linearity solution C:**

- Transfer 20ml of each Methanol, Ethanol and Acetone into a 100ml volumetric flask and dilute to the volume with Ethyl acetate.

**• Detector linearity solution D:**

- Transfer 25ml of each Methanol, Ethanol and Acetone into a 100ml volumetric flask and dilute to the volume with Ethyl acetate.

# QUALIFICATION OF GC...

## **Detector linearity:**

### **Preparation of standard solutions.....**

#### **Detector linearity solution E:**

Transfer 30ml of each Methanol, Ethanol and Acetone into a 100ml volumetric flask and dilute to the volume with Ethyl acetate.

Procedure: Inject blank, followed by Detector linearity solutions and record the peak responses .Draw a standard plot between the concentrations Vs the peak responses.

**Acceptance criteria:** The plot should be linear and regression coefficient (R<sup>2</sup>) should not be less than 0.99.

# QUALIFICATION OF GC...

## **Detector Noise and Drift Test:**

- After GC is ready run the system up to 15 m through single run. After completion of run calculate noise and drift through software.

- **Acceptance criteria:**

Noise NMT: 100  $\mu\text{V}$

Drift NMT: 2500  $\mu\text{V/hr}$

# REFERENCE ...

- Mamatha T, Eshwar C, Venkateshwarlu T, Husna Kanwal Qureshi, Qualification of High Performance Liquid Chromatography System, Journal of Pharmacy Research, 5(7): 3626-3629, 2012.
- Gowrisankar D, Abbulu K, Bala Souri O, Sujana K, Validation and Calibration of Analytical Instruments, Journal of Biomedical Sciences and Research, 2(2): 89-99, 2010.

Thank You

# PROCESS VALIDATION – Tablets, Capsule, Creams & Ointments and Oral Liquids

By

**Dr.A.Anton Smith**

Associate Professor

Department of Pharmacy

Annamalai University.

With

M.Pharm (Q.A) I Year Students (2019-20)

**TABLETS**



# INTRODUCTION

- **Process validation** provides the flexibility and constraints in the production process controls in the achievement of desirable qualities in the drug product while preventing undesirable attributes.
- **USFDA defined** process validation as “establishing documented evidence which provides high degree of assurance that a specific process will consistently produce a product meeting its pre determined specifications and quality characteristics.”

# PROCESS VALIDATION...

## **Importance of Process Validation:**

- Quality of product is assured.
- Optimization of the process.
- The cost of Quality of products is reduced.
- The market recalls of products is minimized.
- The process is under control and detailed study is possible.

# TYPES OF PROCESS VALIDATION

There are four types of process validation.

They are

- Prospective validation.
- Concurrent validation.
- Retrospective validation.
- Revalidation.

# TYPES OF PROCESS VALIDATION...

## **Prospective Process Validation:**

- In prospective process validation, the experimental plan known as validation protocol (following completion of the qualification trials) is prepared before the process is used for commercial use.
- In order to produce support data for validation there is requirement of some degree of prospective experimentation.

# TYPES OF PROCESS VALIDATION...

## **Concurrent Process Validation:**

- The concurrent process validation establishes documented evidence that the process is in a state of control during the actual execution of the process.
- The in-process testing and/or monitoring of critical operations during the manufacture of each production batch is done for concurrent process validation.

# TYPES OF PROCESS VALIDATION...

## **Retrospective Process Validation:**

When validation is based on the historic data taken from the records of the completed production batches and used as a documented evidence for stating that the process has been in a state of control comes under retrospective process validation.

# TYPES OF PROCESS VALIDATION...

## **Revalidation:**

Revalidation ensures that changes in the process and/or in the processing environment, whether intentional or unintentional, do not negatively affect process characteristics and product quality attributes.

Revalidation can be sub-divided into two categories:

- Revalidation after any change having a bearing on product quality.
- Periodic revalidation carried out at scheduled intervals.

# TABLET

- Tablet may be defined as the solid unit dosage form containing one or more medicament with or without suitable excipients and prepared either by molding or by compression.

## **Components of tablet:**

- API (Active Pharmaceutical Ingredient):

Active pharmaceutical ingredient is the term used to refer to the biologically active component of a drug product.



# TABLET...

- Excipients:

Pharmaceutical excipients are substances that are included in a pharmaceutical dosage form not for their direct therapeutic action, but to aid the manufacturing process, to protect, support or enhance stability, or for bioavailability or patient acceptability.

# TYPES OF EXCIPIENT

| Excipient category    | Function in formulation  | Examples  |
|-----------------------|--|---|
| Diluents              | Fillers  | Lactose, Starches, Dextrose, Sorbitol, Cellulose  |
| Binders and Adhesives | Impart cohesive qualities to powdered material.  | Acacia, Gelatin, Glucose, Carboxymethyl cellulose   |
| Lubricants            | Reduce inter-particle friction, prevent adhesion of tablet material to the surface of dies and punches facilitate easy ejection of tablet from die cavity and improve the rate of flow tablet granulation. | Talc, Stearic acid, Magnesium stearate, Calcium stearate, Polyethylene glycol, vegetable oil. |

# TYPES OF EXCIPIENT...

| Excipient category | Function in formulation   | Examples   |
|--------------------|---|--|
| Glidants           | Improve flow characteristics of powder mixture.   | Colloidal Silicone dioxide (Carbosil), Asbestos free starch, Corn starch |
| Disintegrants      | Facilitate breakup or disintegration after administration   | Starches, Clays, Cellulose, Cross linked polymers,                       |
| Superdisintegrants | Improved disintegrant efficacy resulting in decreased use levels when compared to traditional disintegrants | Cross Povidone   |

# TYPES OF EXCIPIENT...

| Excipient category  | Function in formulation  | Examples                                      |
|---|--|---|
| Coloring agents<br>(these must be approved<br>and certified by F.D.A) | Impart aesthetic appearance<br>to dosage form, disguising<br>off color drugs, product<br>identification. | FD and C, D and C dyes<br>and lakes           |
| Flavoring agent   | Limited to chewable tablets/<br>tablets intended to dissolve<br>in mouth                                 | Spray dried and other<br>flavors, syrups etc. |
| Sweetening agent  | Impart sweet taste to the<br>formulation; use is limited to<br>chewable tablets                          | Mannitol, Saccharin                           |

# TYPES OF EXCIPIENT...

| Excipient category | Function in formulation   | Examples  |
|--------------------|---|---|
| Sorbents           | Moisture proofing   | Silica gel, activated carbon, clay etc  |
| Coating materials  | Protect tablet ingredients from deterioration by moisture, help swallowing unpleasant tasting tablets | Hydroxy propyl methyl cellulose (HPMC), Synthetic polymers, Polysaccharides, Capslues coated by Gelatin, Ethyl cellulose. |
| Plasticizers       | For soft gelatin capsule preparation, gelatin based suppositories, film coated tablets etc.           | Castor oil, Diacetylated Monoglycerides, Polyethylene glycol, Polypropylene glycol  |

# PROCESS VALIDATION OF TABLETS

Numerous factors should be considered when developing and validating solid dosage forms:

- Blending
- Granulation
- Drying
- Milling
- Lubrication
- Compression
- Coating

# Mixing or Blending

- Mixing is one of the most critical step and used at various stages during manufacturing of tablets.
- Materials with like physical properties can easily form a uniform mix or blend and not segregate as soon as materials with large differences.

# Mixing or Blending...

Parameters to consider:

## **A. Mixing Or Blending Technique:**

- The techniques like Diffusion (tumble), convection (planetary or high intensity), or pneumatic (fluid bed) are used to mix or blend materials.
- The choice of technique depends on whether the drug and excipients are mixed for a direct compression formulation or for adding the lubricant (e.g., Magnesium stearate) to the granulation.



# Mixing or Blending...

## **B. Mixing or Blending Speed:**

- Mixing the drug and excipient requires more intense mixing than adding the lubricant to the final blend.

## **C. Mixing or blending time:**

- The mixing or blending time of the product will be dependent on the mixing or blending technique and speed.

# Mixing or Blending...

## **D. Drug uniformity:**

- The test for content uniformity is usually performed to estimate the uniformity of drug throughout the mix or blend.

## **E. Excipient uniformity:**

- Besides drug uniformity, excipients uniformity is also necessary in the granulation or blend. Two key excipients are:

# Mixing or Blending...

## **F.Lubricant:**

- Uneven distribution of the lubricant can result in picking and sticky problems during compression.
- It can also lead to tablet performance problems (low dissolution due to excessive lubricant in some tablets).

## **G.Color:**

- The colorant(s) need(s) to be evenly distributed in the mixture so that the tablets have a uniform appearance (e.g., color, hue, and intensity).

# Mixing or Blending...

## **H. Equipment capacity/load:**

- The bulk density of materials or granules will affect the capacity of the equipment.
- Undercharging or overcharging a blender can result in poor drug or tablet lubricant distribution.

# Sampling

- Set and operate the blender.
- Load the sifted materials into the blender except lubricant.
- Start the blender in inch mode and check for any leakage of material.
- On ensuring that there is no leakage, blend for 25 minutes.
- Samples to be drawn from 10 locations of the blender.

# Sampling...

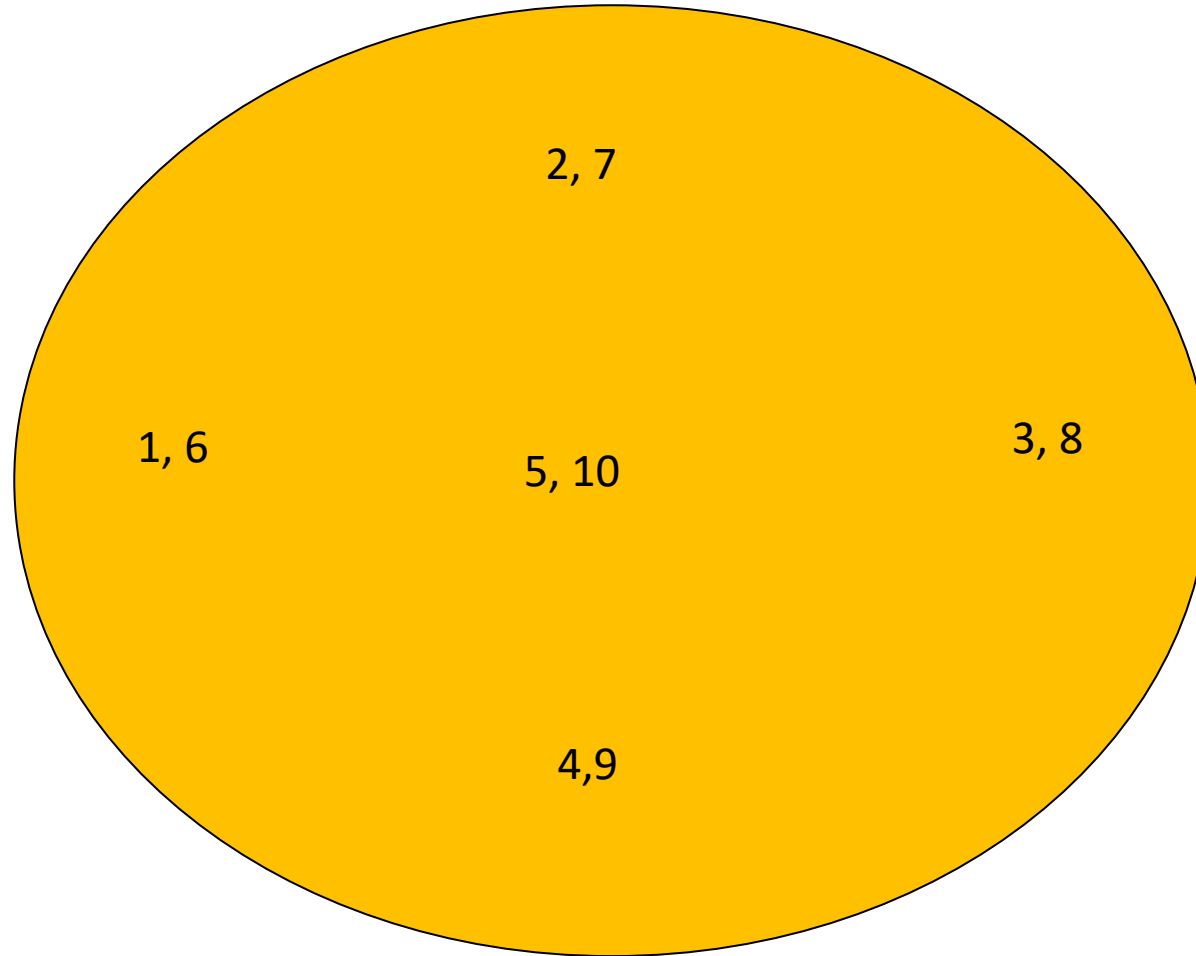

# Sampling...

In addition to this following tests shall be carried out for information purpose:

- Content uniformity and its RSD
- Bulk density
- Sieve analysis
  - Compressibility index.

# Blending equipment

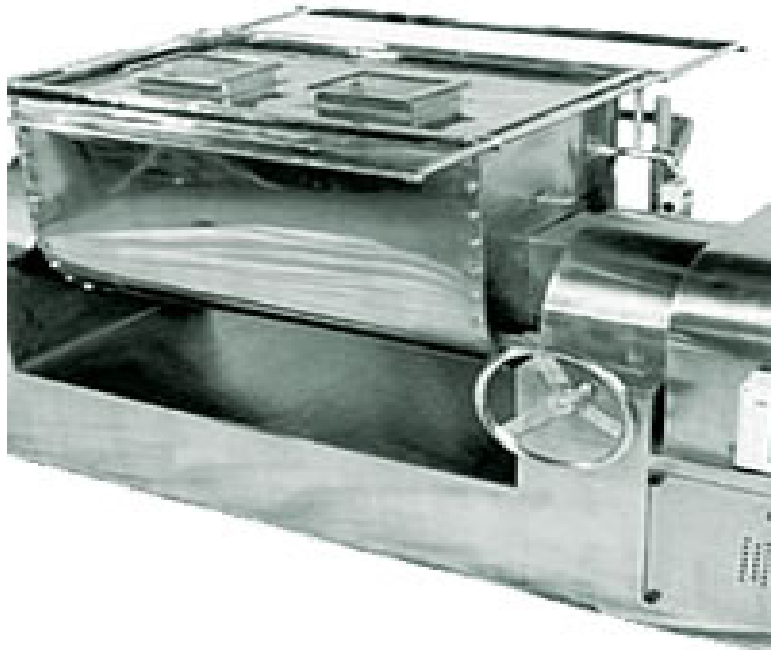

MASS MIXER



DOUBLE CONE BLENDER



# Blending equipment...



OCTANGONAL BLENDER



V-CONE BLENDER

# Blending equipment...



Conta Blender



Saizoner

# Blending equipment...



Ribbon Blender



Planetary Mixer



Plough Shear Mixer

# Granulation

- Granulation is a size enlargement operation by which a fine powder is agglomerated into larger granules in order to produce a specific size and shape, to improve flowability and appearance and to reduce dustiness.

## **Wet granulation :**

- Parameters to be considered during development and validation are:

# Granulation...

## **A. Binder Addition:**

Adding the binder drying is avoided, the need to determine the optimal binder concentration and a separate manufacture for the binder solution.

## **B. Binder Concentration:**

- The optimal binder concentration will need to be determined for the formulation.
- If the binder is to be sprayed, the binder solution needs to be dilute enough so that it can be pumped through the spray nozzle.

# Granulation...

- It should also be sufficiently concentrated to form granules without over wetting the materials.

## **C. Amount of Binder Solution/Granulating Solvent:**

- Too much binder or solvent solution will over wet the materials and prolong the drying time. The amount of binder solution is related to the binder concentration.

# Granulation...

## **D. Binder Solution/Granulating Solvent Addition Rate:**

The rate or rate and range at which the binder solution or granulating solvent can be added to the materials should be defined properly.

## **E. Mixing Time:**

- Granulations that are not mixed long enough can form incomplete or weak granules. These granules may have poor flow and compression properties.
- On the other hand, over mixing the granulation can lead to harder granules and a lower dissolution rate.

# Sampling

- Add ingredient into vessel then dissolve.
- Add the other ingredients into a granulator and mix of 5 minutes using impeller at slow speed.
- Collect, samples at 3,5 and 7 minutes at 5 different places and subject it to analysis for uniformity in content.
- Add granulating solution and homogenize at slow speed for about 10 minutes.
- After granulation is over check the loss of drying of wet granules.



Sampling...

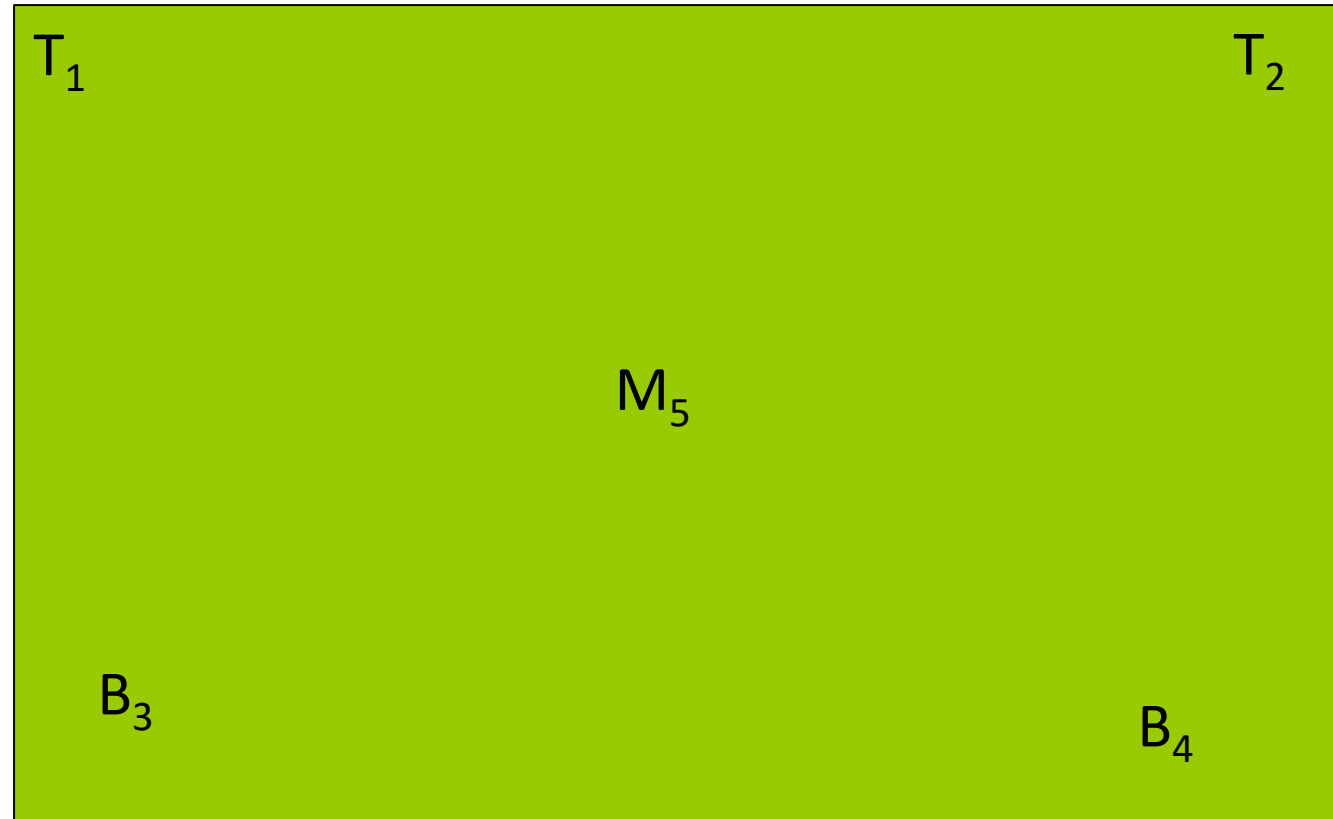

# Granulators



RMG



FBG

# Wet milling

Sometimes wet milling of granules is needed before subjecting it for drying to efficiently dry them. Factors to consider are:

## **A. Equipment Size and Capacity:**

The mill should be large enough to de lump the entire batch within a reasonable time period to minimize manufacturing time and prevent the material from drying during this operation.

# Wet milling...

**B. Screen Size:** The screen needs to be small enough to de lump the material, but not too small to cause excessive heating of the mill, resulting in drying of the granulation.

**C. Mill Speed:**

The speed should be sufficient to efficiently de lump the material without straining the equipment.

**D. Feed Rate:** The feed rate of the wet granulation is interrelated to screen size and mill size and speed.

# Drying

- Drying is a mass transfer process consisting of the removal of water or another solvent by evaporation from a solid, semi-solid or liquid.
- The type of drying technique (e.g., tray, fluid bed, and microwave) required for the formulation needs to be determined and justified. Changing dryer techniques could affect such tablet properties as hardness, disintegration, dissolution, and stability.

# Drying...

The optimal moisture content of the dried granulation needs to be determined.

- High moisture content can result in  
Tablet picking or sticking to tablet punch surfaces and  
Poor chemical stability as a result of hydrolysis.
- An over dried granulation could result in poor hardness and friability.

# Drying...

Parameters to consider are:

## **A. Inlet/Outlet Temperature:**

- The inlet temperature is the temperature of the incoming air to the dryer, while the outlet temperature is the temperature leaving the unit.
- The inlet temperature is critical to the drying efficiency of the granulation and should be set high enough to maximize drying without affecting the chemical/physical stability of the granulation.

# Drying...

- The outlet temperature is an indicator of the granulation temperature and will increase toward the inlet temperature as the moisture content of the granulation decreases (evaporisation rate).

## **B. Air flow:**

- There should be sufficient air flow to ensure removal of moisture laden air from the wet granulation. Insufficient air flow could prolong drying and affect the chemical stability of the drug.



# Drying...

## **C. Moisture Uniformity:**

The moisture content could vary within the granulation

## **D. Equipment Capability/Capacity:**

The load that can be efficiently dried within the unit needs to be known.

# Sampling

- Check and ensure the integrity of the fluid bed drying.
- Initially dry the wet granules with air for 10 minutes, dry the granules are per BMR.
- Check the loss of drying of granules .
- It should not be more than 1% at 70°C for 15 minutes,
- Check and ensure the dried granules are not stored above 25°C before the milling is started.

# Sampling...

- Check and ensure the integrity of the sieves before and after sieving
- Pass the granules through 16mm mesh sieve, break the oversize granules using mill fitted with 2mm screen.
- Collect the granules in poly bags, and check for the flow properties
- Check the weight of sifted and dried granules.

Sampling...

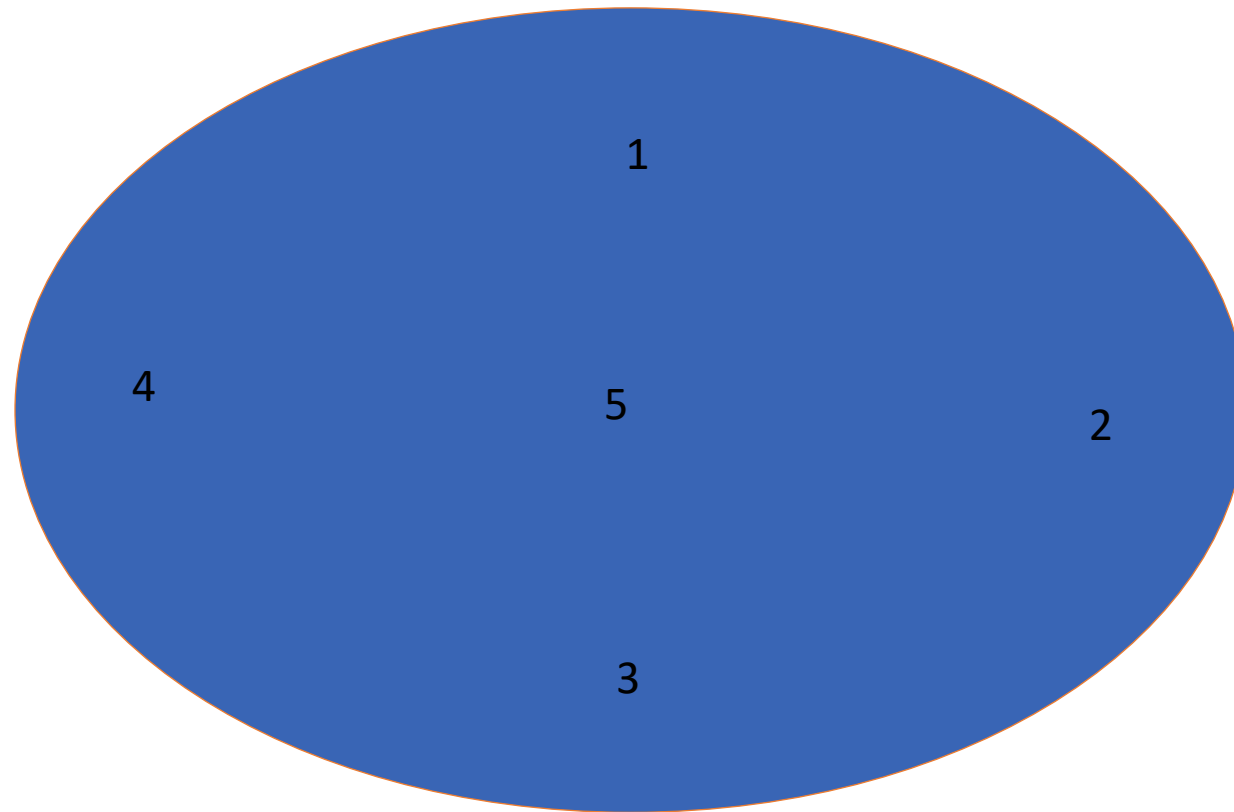

# Drying equipment



FBD



TRAY DRYER



SPRAY DRYER

# Dry milling

- The milling operation will reduce the particle size of the dried granulation. The resultant particle size distribution will affect such material properties as flow, compressibility, disintegration, and dissolution.
- An optimal particle size/size distribution for the formulation will need to be determined. Factors to consider in dry milling are same as that of wet milling.

# Milling equipment...



**CUTTING MILL**



**FLUID ENERGY MILL**

# Milling equipment...



**ROLLER MILL**



**COLLOID MILL**



# Lubrication

Lubricants are added in order to remove the problem of sticking and picking in the tablets.

**A. Selection of Lubricant:** Grade of the lubricant used and compatibility with other ingredients should be studied thoroughly and then the appropriate one must be chosen.

# Lubrication...

## **B. Amount of Lubricant Added:**

How much lubricant is required? Too much lubricant will form hydrophobic layer on the tablet resulting in dissolution problems.

## **C. Mixing Time:**

The optimum mixing time must be decided on proper trial of batches because if not mixed long enough form problems like chipping, capping, etc.

# Sampling

- Perform the pre mixing and final mixing as per BMR.
- During the final mixing before adding the remaining quantity of the lubricant mix for 15 minutes.
- Collect samples at 5, 10, 15 minutes intervals from top, middle, bottom.
- Composite and subject it to analysis for assay.

# Sampling...

- After adding remaining quantity of lubricant mix for 5min.
- Collects sample at 3, 5, 7 minutes interval from top, middle, bottom.
- Composite and subject it to analysis for assay and content uniformity.
- Check the weight of the final blend and record.

# Compression

Compression is a critical step in the production of a tablet dosage form. As for the compressibility properties of the formulation, it should be examined on an instrumented tablet press. Factors to consider during compression are as follows:

## **A.Tooling:**

The shape, size, and concavity of the tooling should be examined based on the formulation properties and commercial specifications.

# Compression...

## **B.Compression speed:**

The formulation should be compressed at a wide range of compression speeds to determine the operating range of the compressor.

## **C.Compression/ejection force:**

The compression profile for the tablet formulation will need to be determined to establish the optimal compression force to obtain the desired tablet hardness.

# Compression...

The following in-process tests should be examined during the compression stage:

- ❖ **Appearance**
- ❖ **Hardness**
- ❖ **Thickness**
- ❖ **Tablet weight**
- ❖ **Friability**
- ❖ **Disintegration**
- ❖ **Content uniformity**

# In-process test

## **HARDNESS:**

- First 20, last 20, middle 20 tablets (throughout the run)
- Determine mean and standard deviation for baseline.

## **Acceptance Criteria:**

Chewable tablets-  $3\text{kg}/\text{cm}^2$

Tablets-  $4\text{-}8\text{kg}/\text{cm}^2$

sustained release tablets & troches-  $10\text{-}20\text{kg}/\text{cm}^2$



# In-process test...

## **THICKNESS:**

- First 20, last 20, middle 20 tablets (throughout the run)
- Determine mean and standard deviation.

## **Acceptance Criteria:**

The Relative Standard Deviation should be less than or equal to 5%.

# In-process test...

## **FRIABILITY:**

- First 20, last 20, middle 20 tablets

Initial weight – final weight

~~———— Initial weight ×100 ————~~

## **Acceptance Criteria:**

Weight loss less than or equal to 1%, as per USP.

# In-process test...

## **CONTENT UNIFORMITY:**

- Select 30 tablets randomly from batch
- Assay individually

## **Acceptance Criteria:**

Out of 30 tablets 3 tablets can be with in 75 – 125% and all other tablets should be with in 85 -115%

# In-process test...

## **WEIGHT VARIATION:**

- 20 – TABLETS

(Individual weight - Average weight)

Average weight × 100

- Determine mean and standard deviation.

## **Acceptance Criteria:**

- For Average weight 130 mg or less 10% difference

# In-process test...

- For Average Weight 130 to 324 mg 7.5% difference
- For Average Weight More than 324 mg 5% difference

Not more than two tablets have a variation as large as that shown; no tablet is twice the variation.

# In-process test...

## DISINTEGRATION TEST:

| TABLETS        | DISINTEGRATION TIME |
|----------------|---------------------|
| Un coated      | 15min               |
| Plain coated   | 60min               |
| Enteric coated | 3hrs                |
| Dispersible    | 3min                |
| Effervescent   | <3min               |
| Sublingual     | 4hr                 |
| Buccal         | 4hr                 |

# In-process test...

## **Acceptance Criteria:**

- All tablets have to disintegrated completely.
- If 1 or 2 tablets fails to disintegrate completely repeat the test for 12 additional tablets.
- Not less than 16 out of 18 tablets tested disintegrated completely.

# Compression equipment





# Compression equipment...

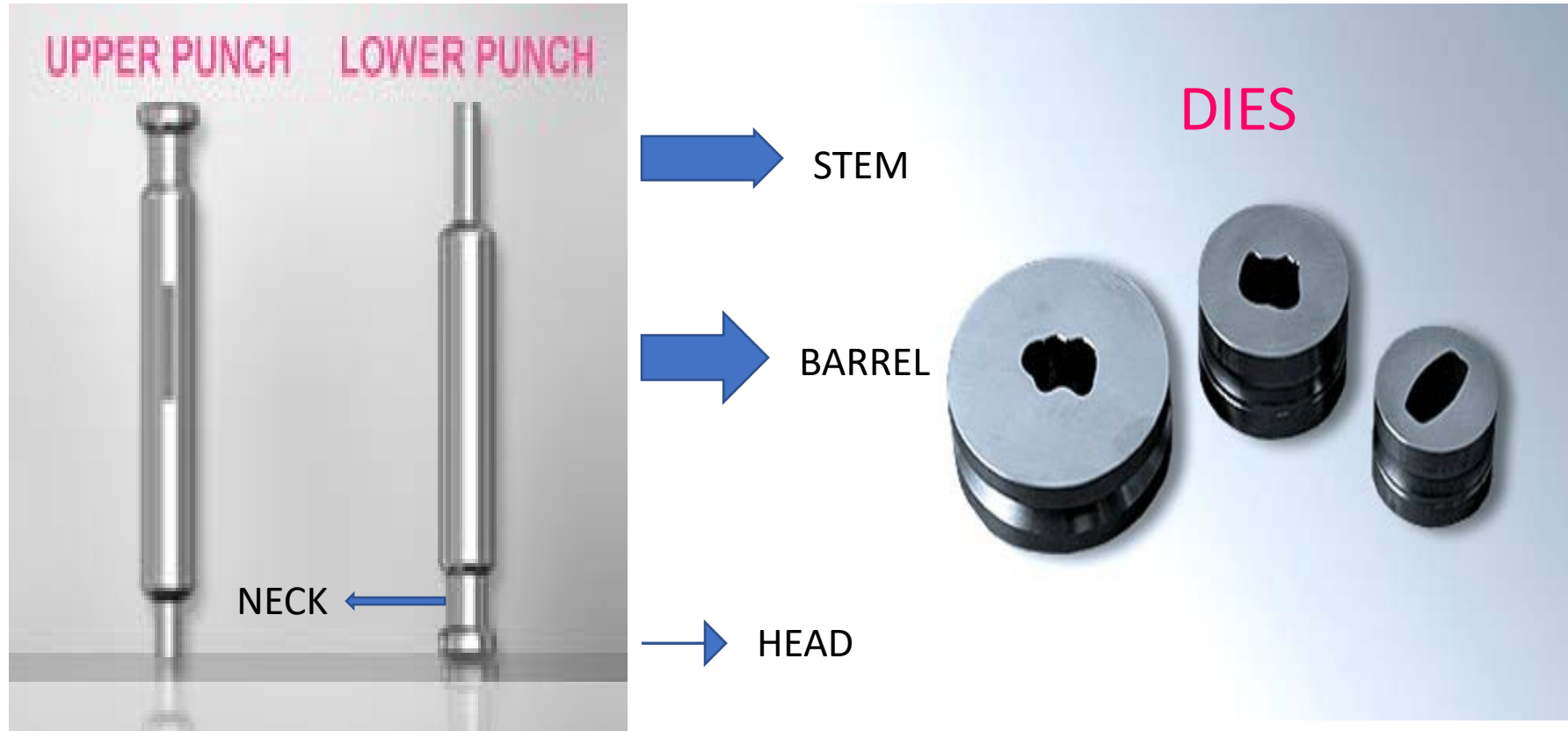

# Coating

- A **tablet coating** is a covering over a **tablet**, used to mask the taste, make it easier to swallow, or protect the active medication inside.
- A **tablet coating** is applied to make the **tablet** smoother and easier to swallow. A **tablet coating** colors and protects the **tablet**, and masks a bad taste.
- Tablet properties such as hardness, shape and intagliation are important to obtain a good film-coated tablet.

# Coating...

- The tablet needs to be hard enough to withstand the coating process. If tablet attrition occurs, the tablets will have a rough surface appearance.
- For tablet shape, a round tablet will be easier to coat than tablets with multiple edges because of the uniformity of surface.
- For intagliated tablets, the intagliation style and depth should be developed to prevent fill-in or chipping of the intagliation.

# Coating...

**Tablet coating can occur by different techniques (e.g., sugar, film, or compression).**

Film coating has been the most common technique over recent years and will be the focus of this section.

Key areas to consider for tablet coating include the following:

## **A. Tablet Properties:**

Tablet properties such as hardness, shape, and intagliation (if required) are important to obtain a good film-coated tablet. The tablet needs to be hard enough to withstand the coating process

# Coating...

## **B. Equipment Type:**

The type of coater will need to be selected. Conventional or perforated pan and fluid bed coaters are potential options.

## **C. Coater Load:**

Having too large a pan load could cause attrition of the tablets because of the overall tablet weight in the coater. In the case of a fluid bed coater, there may not be sufficient airflow to fluidize the tablets.

## **D. Pan Speed:**

This will be interrelated to other coating parameters, such as inlet temperature, spray rate, and flow rate.

# Coating...

## **E.Spray Guns:**

The number and types of guns should be determined in order to efficiently coat the tablets.

## **F.Application/Spray Rate:**

- The optimal application/spray rate should be determined. Spraying too fast will cause the tablets to become over wet, resulting in clumping of tablets and possible dissolution of the tablet surface.
- Spraying too slowly will cause the coating materials to dry prior to adhesion to the tablets. This will result in a rough tablet surface and poor coating efficiency.

# Coating...

## **G.Tablet Flow:**

The flow or movement of the tablets in the coater should be examined to ensure proper flow. The addition of baffles may be required to provide adequate movement of tablets for tablet coating.

## **H.Inlet/Outlet Temperature and Airflow:**

These parameters are interrelated and should be set to ensure that the atomized coating solution reaches the tablet surface and then is quickly dried.

# Coating...

## **I.Coating Solution:**

The concentration and viscosity of the coating solution will need to be determined. The solution will need to be sufficiently diluted in order to spray the material on the tablets.

## **J.Coating Weight:**

A minimum and maximum coating weight should be established for the tablet.

## **K.Residual Solvent Level:**

If solvents are used for tablet coating, the residual solvent level will need to be determined



# Coating...

## Validation Protocol for Tablet Coating Process

XXXXXXXXXXXXXXXXXXXXXXXXXXXXXXXXXXXX

|  |  |
|--|--|
| <b>QUALITY ASSURANCE</b><br><br><b>PROCESS VALIDATION PROTOCOL<br/>FOR TABLETS</b> | <b>Protocol No. : XXXXXXXXXXXXXXXXXXXX</b> |
|  | <b>Rev. :00</b>                            |
|  | <b>Supersedes: NIL</b>                     |
|  | <b>Protocol prepared on: XXXXXXXXXXXX</b>  |
|  | <b>Effective Date: XXXXXXXXXXXXX</b>       |
| <b>Page 26 of 33</b>   |  |

| <b>VALIDATION<br/>PARAMETER</b> | <b>OBSERVATION</b> | <b>ACCEPTANCE CRITERIA</b> |
|---------------------------------|--------------------|----------------------------|
| Speed of coating pan            |                    | Specified In-house Limits  |
| Spray Rate                      |                    | Specified In-house Limits  |
| Bed temperature                 |                    | Specified In-house Limits  |
| Air Pressure                    |                    | Specified In-house Limits  |

**Remarks:**

**Checked By:**

**Date:**

# Coating...

## Validation Protocol for Tablet Coating Process

### Data recording sheet V

|                             |            |                    |               |             |
|-----------------------------|------------|--------------------|---------------|-------------|
| <b>Coating Stage</b>        |            |                    |               | <b>Date</b> |
| Name of equipment           | :          |                    |               |             |
| Identification no           | :          |                    |               |             |
| Capacity                    | :          |                    |               |             |
| Speed of coating pan        | :          |                    |               |             |
| Temperature of area         | :          |                    |               |             |
| Temperature of blower       | :          |                    |               |             |
| Spray rate                  | :          |                    |               |             |
| Bed temperature             | :          |                    |               |             |
| Air Pressure                | :          |                    |               |             |
| Total coating solution used | :          |                    |               |             |
| Weight build up             | :          |                    |               |             |
|                             | Tablet     | Prepared By        | : Reviewed by | Approved by |
|                             |            |                    |               |             |
| Designation                 | QA chemist | Production Manager | Manager QC&A  | Plant head  |
| Date                        |            |                    |               |             |
| Format No.: xxxxxxxxxxxxxx  |            |                    |               | 24          |

# TABLET COATING EQUIPMENTS



Accela cota



Hi coater



Glatt cota

# Department responsibility and Process validation parameters

| Department /Designation | Responsibility   |
|-------------------------|--|
| Manager Production      | Responsible for manufacturing of batches and review of protocol and report.      |
| Manager QC              | Responsible for analysis of samples Collected.                                   |
| Executive QC            | Responsible for samples collection and submission to QC.                         |
| Manager Maintenance     | Providing utilities and engineering Support.                                     |
| Executive Production    | Responsible for preparation of protocol and manufacturing of validation batches. |
| Manager QA              | Responsible for protocol authorization and preparation of summary report.        |

# Process steps & Controlled Variables

| Sr. No | PROCESS STEPS | CONTROLLED VARIABLES  | TEST  |
|--------|---------------|---|---|
| 1      | Pre-blending  | Blending time, RPM, Load size, Order of addition.   | Blend uniformity  |
| 2      | Granulation   | Mixing speed, Amount of granulating fluid, Feed rate, granulation time, Load.                               | Drug distribution, water content, size                              |
| 3      | Drying        | Initial temperature, Outlet temperature, Drying temperature.  | Particle size, LOD, densities, distribution.                        |
| 4      | Milling       | Screen size, Milling Speed, Feed rate.  | Particle size, bulk and tap densities.                              |
| 5      | Lubrication   | Blending time, Load size, Blender speed.  | Particle size distribution, bulk and tap densities, flow properties |
| 6      | Compression   | Compression rate, Granule feed rate, Pre-compression force, and Compression force.                          | Appearance, hardness, thickness. Friability, Assay                  |
| 7      | Coating       | Pan load, Inlet/Exhaust temperatures, Inlet/Exhaust humidifiers, Pan speed, Atomizing pressure, Spray rate. | Thickness, dissolution assay, % wt gain,                            |

# REFERENCE

- Goyal Anju, Priyambada Pandey (2017), Process Validation of Pharmaceutical Dosages Form: A Review. Biomedical Journal of Scientific and Technical Research.
- James Agalloca, Frederick J Carleton (2007), Validation of Pharmaceutical Process.(3<sup>rd</sup> edition). Informa Healthcare.
- Nash R A, Wachter AH (2003) Pharmaceutical Process Validation, (3<sup>rd</sup> edition). Marcel Dekker, Inc, New York, USA.

**CAPSULE**

# PROCESS VALIDATION OF CAPSULES

- **Capsules** are the solid dosage form in which the drug or the mixture of drugs with or without excipients that are enclosed in Hard Gelatin capsules shells, in soft soluble shells of gelatin, or in hard or soft shells of any other suitable materials, of various shape and capacities.
- They usually contain a single dose of active ingredients and are intended for oral administration.
- They are basically of two types:
  - **A) Hard Gelatin Capsules.**
  - **B) Soft Gelatin Capsules.**



# HARD GELATIN CAPSULE

- It is a solid dosage form in which medications are encapsulated in a two part empty hard gelatin capsule shell.
- The upper and small part is called 'CAP' and the remaining large part is called 'BODY'.
- There are 8 different fill volume.
- Normally 0 and 2 sized shells are widely used.
- The shell of hard gelatin capsules basically consists of gelatin, plasticizers and water.
- Modern day shells may, in addition, consist of preservatives, colours, pacifying agents, flavours, sugars, acids, enteric materials etc.

## FOR **HARD** GELATIN CAPSULE:

| SR NO. | VARIABLE            | RESPONSE  |
|--------|---------------------|---|
| 1.     | MACHINE SPEED       | DOSE UNIFORMITY   |
| 2.     | BED HEIGHT          | WEIGHT VARIATION  |
| 3.     | COMPACTION PRESSURE | APPEARANCE/<br>LENGTH   |
| 4.     | DOSING PRESSURE     | CONTENT<br>UNIFORMITY   |
| 5.     | CLOSING VOLUME      | A. DISSOLUTION<br>B. MICROBIAL COUNT<br>C. MOISTURE<br>CONTENT<br>(BRITTLENESS) |

# SOFT GELATIN CAPSULE

- A soft gel (soft gelatin capsule) is a solid capsule (outer shell) surrounding a liquid or semi-solid Centre (inner fill).
- An active ingredient can be incorporated into the outer shell, the inner fill, or both.
- The process of manufacturing of hard gelatin capsules is same as that of tablets, the only difference is that instead of compressing the granules they are filled in the capsules shell.
- So the validation process is also the same.

## **FOR SOFT GELATIN CAPSULE:**

| <b>SR NO.</b> | <b>VARIABLE</b>                                    | <b>RESPONSE</b>  |
|---------------|--|--|
| 1.            | <b>SPEED OF DIE ROTATION</b>                       | <b>ELEGANCE/ COLOR</b>   |
| 2.            | <b>TEMPERATURE OF GELATIN</b>                      | <b>CAPSULE FILL WEIGHT</b>   |
| 3.            | <b>RIBBON THICKNESS</b>                            | <b>CAPSULE SHELL WEIGHT</b>  |
| 4.            | <b>TEMPERATURE AND HUMIDITY OF PROCESSING AREA</b> | <b>A. CAPSULE WALL THICKNESS<br/>B. ASSAY AND CONTENT UNIFORMITY<br/>C. DISSOLUTION<br/>D. MOISTURE CONTENT<br/>E. LEAK TEST</b> |

# PROCESS FLOW AND VARIABLES

## PROCESS FLOW

ADDITION OF:  
1. RAW MATERIALS,  
2. API AND  
3. EXCIPIENTS

MIXING AND MIXER

ADDITION OF  
LUBRICANTS AND  
DISINTEGRANTS

BLENDING AND  
BLENDER

CAPSULATING

## CONTROL VARIABLES

1. LOAD SIZE
2. RPM
3. MIXING TIME

1. LOAD SIZE
2. RPM
3. BLENDING TIME

1. CAPSULATION SPEED
2. POWER FEED RATE

## MEASURED RESPONSED

MIX UNIFORMITY

1. BLEND UNIFORMITY
2. FLOW CHARACTERISTICS

1. WEIGHT VARIATION
2. DISINTEGRATION TIME AND
3. LOCKING

# CAPSULE SIZE AND VOLUME

| Sr No. | Capsule Size | Volume (ml) |
|--------|--------------|-------------|
| 1.     | 000          | 1.37        |
| 2.     | 00           | 0.95        |
| 3.     | 0            | 0.68        |
| 4.     | 1            | 0.50        |
| 5.     | 2            | 0.37        |
| 6.     | 3            | 0.30        |
| 7.     | 4            | 0.20        |
| 8.     | 5            | 0.13        |



## Various Sizes of Capsules:

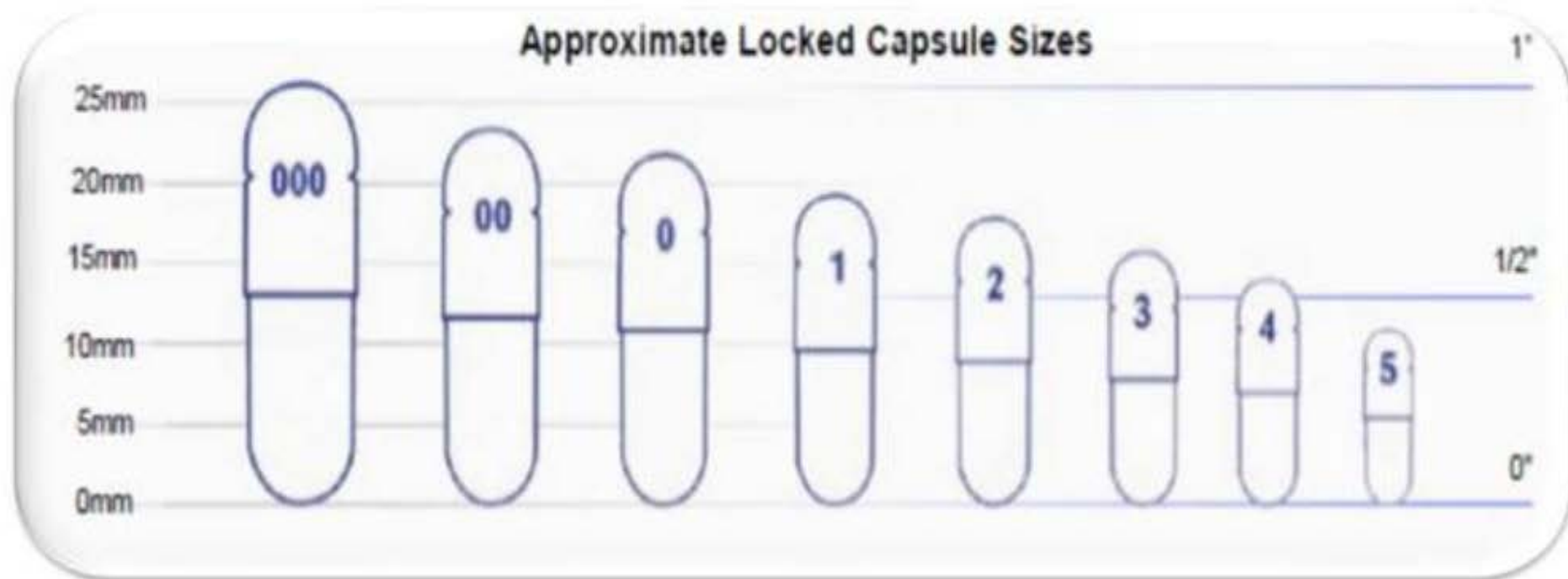

# FILLING OF VARIOUS ENTITIES

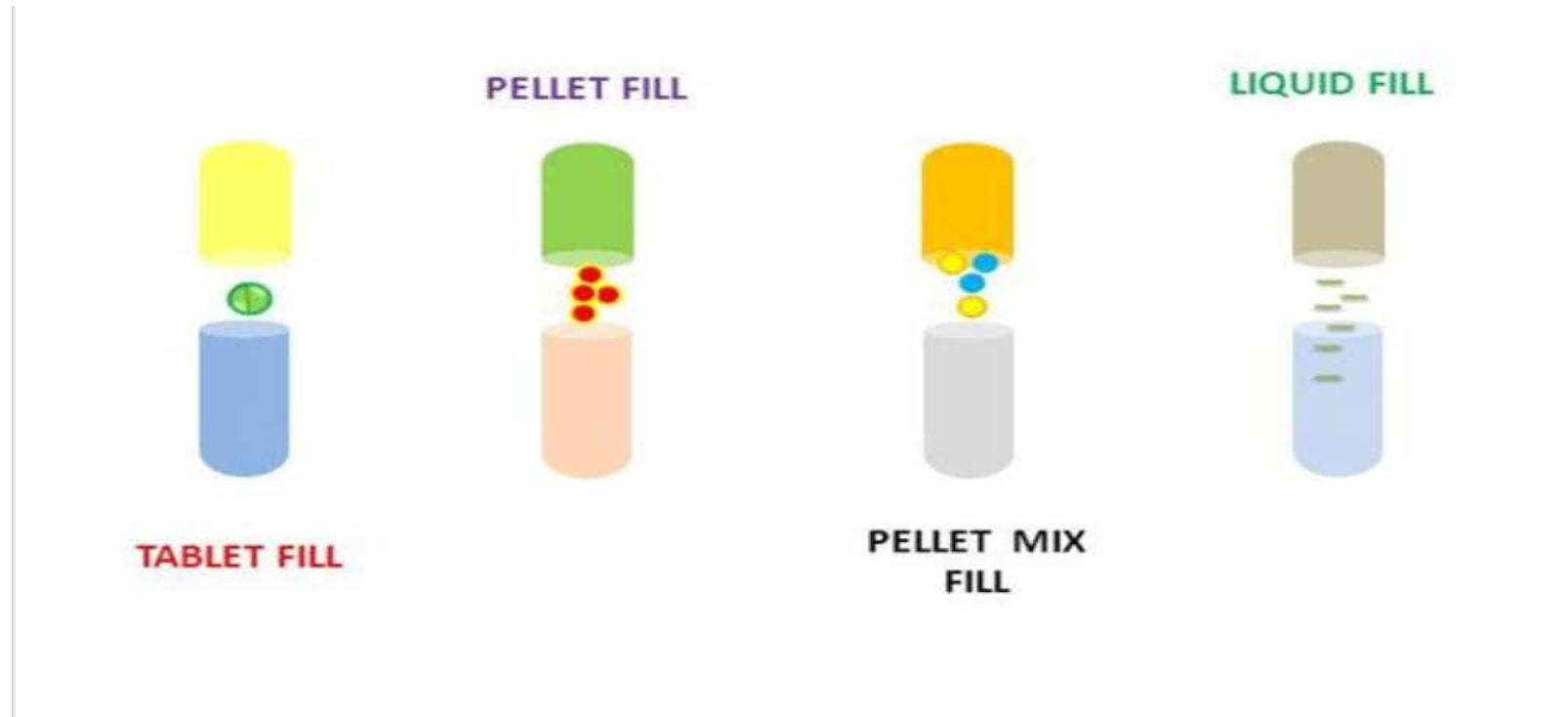



# TYPES OF FILLING MACHINE

- Tamping-In and Stroking
- Continuous Tamping
- Auger Filling
- Compression Filling
- Vacuum Fill

# TAMPING AND VOLUME FILL

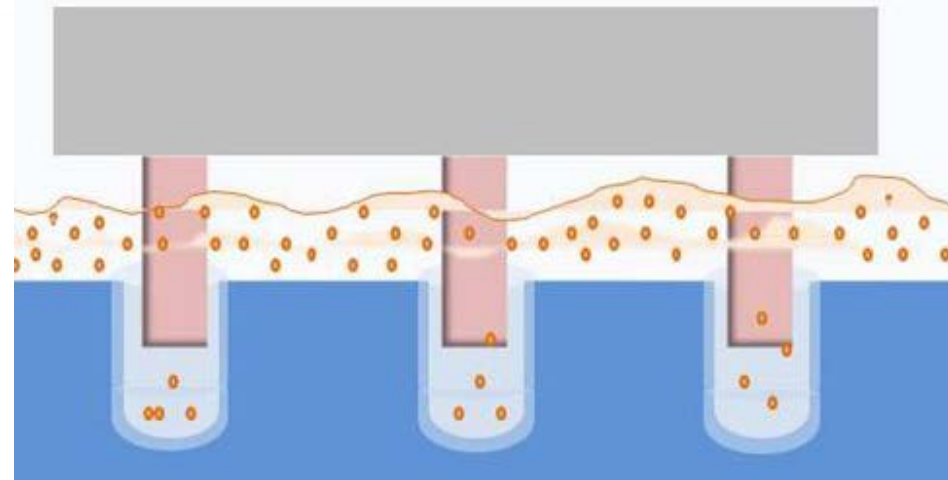
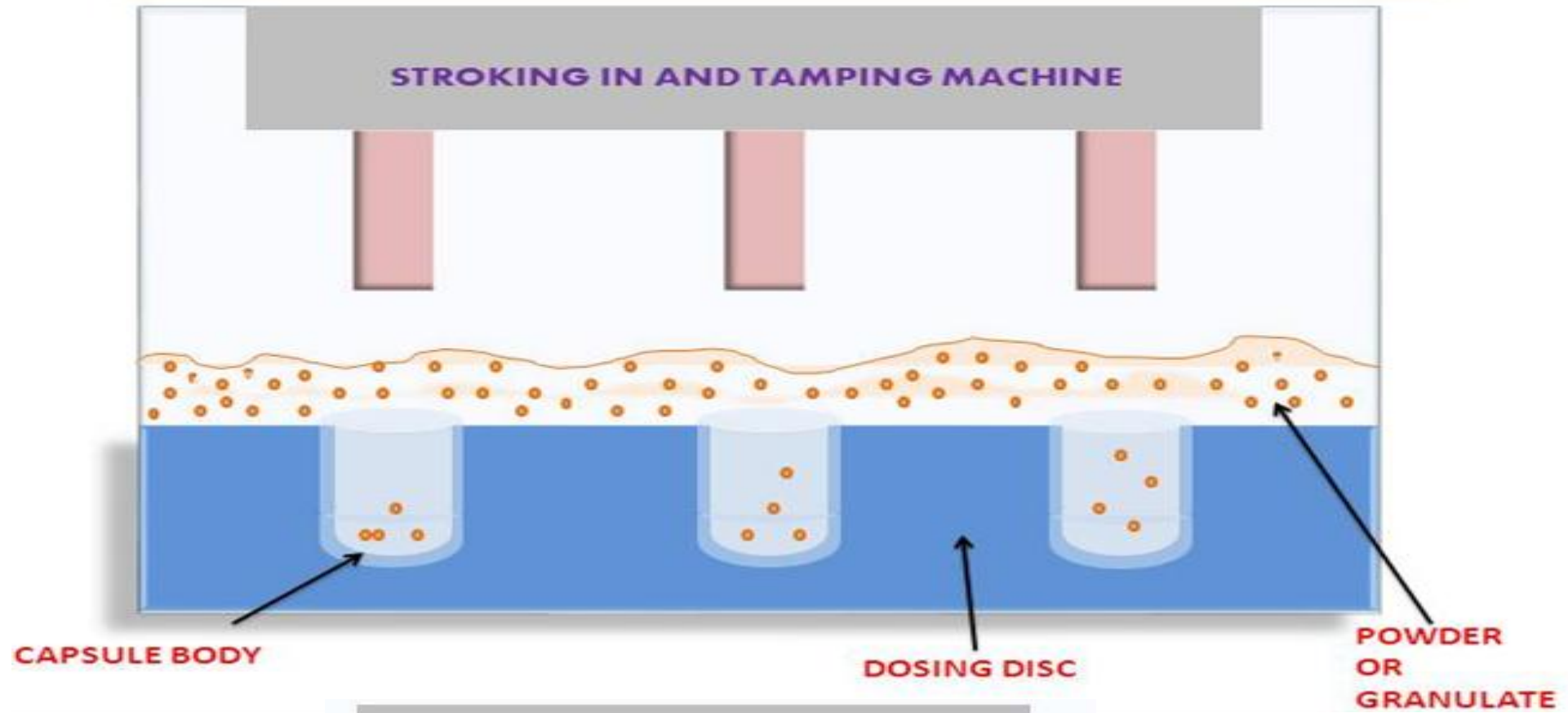

# CONTINUOUS TAMPING FILLING

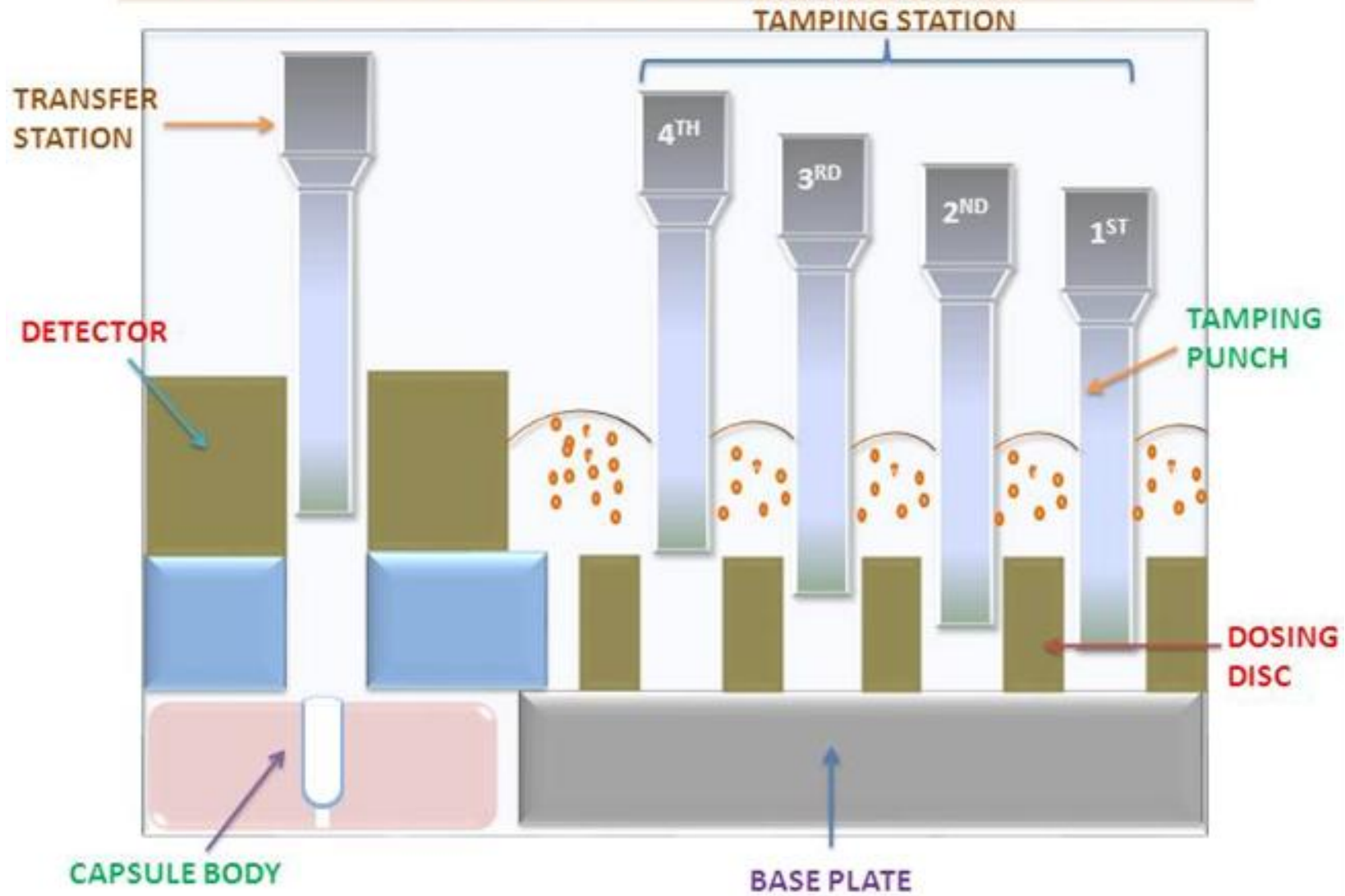

# AUGER MECHANISM OF FILLING

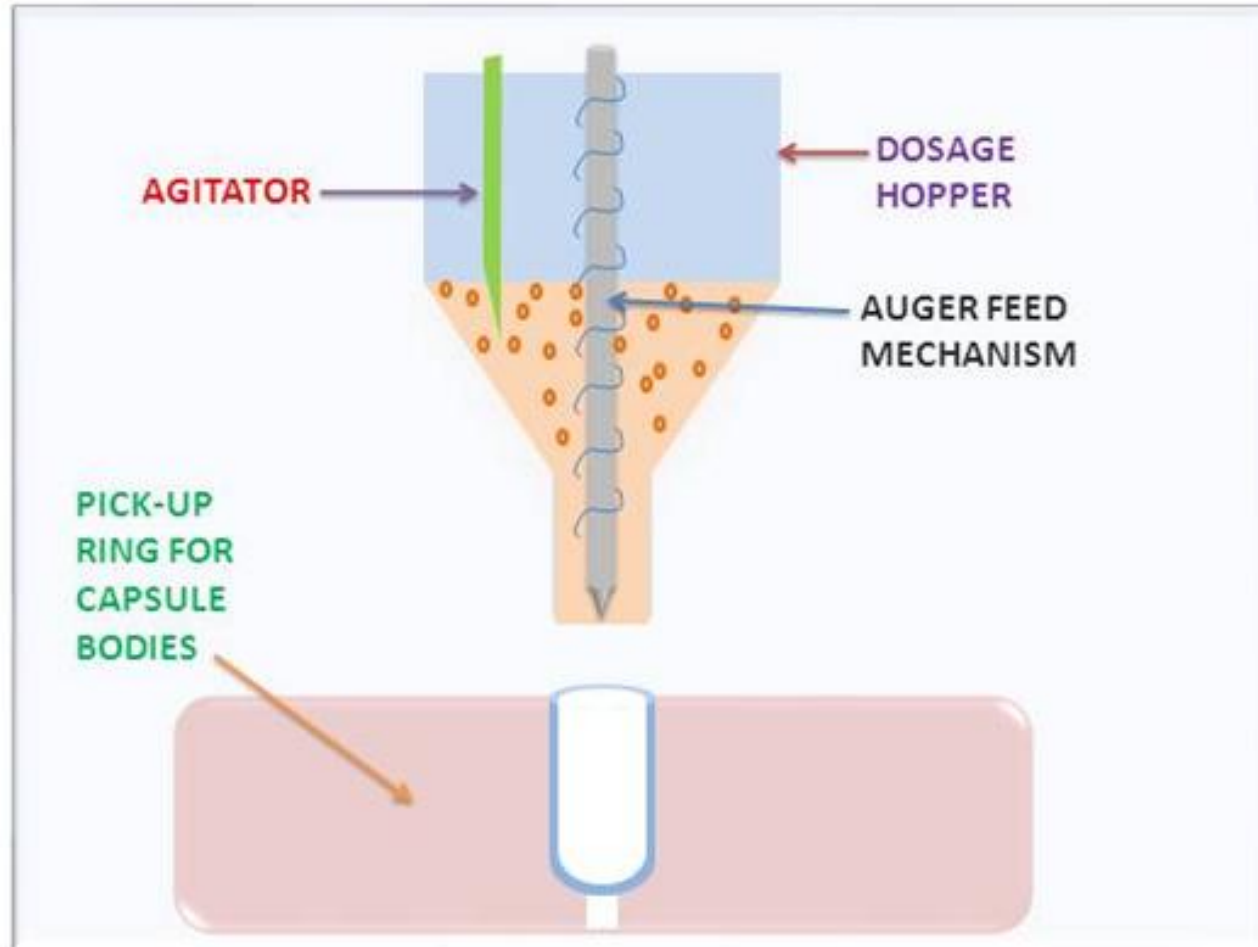

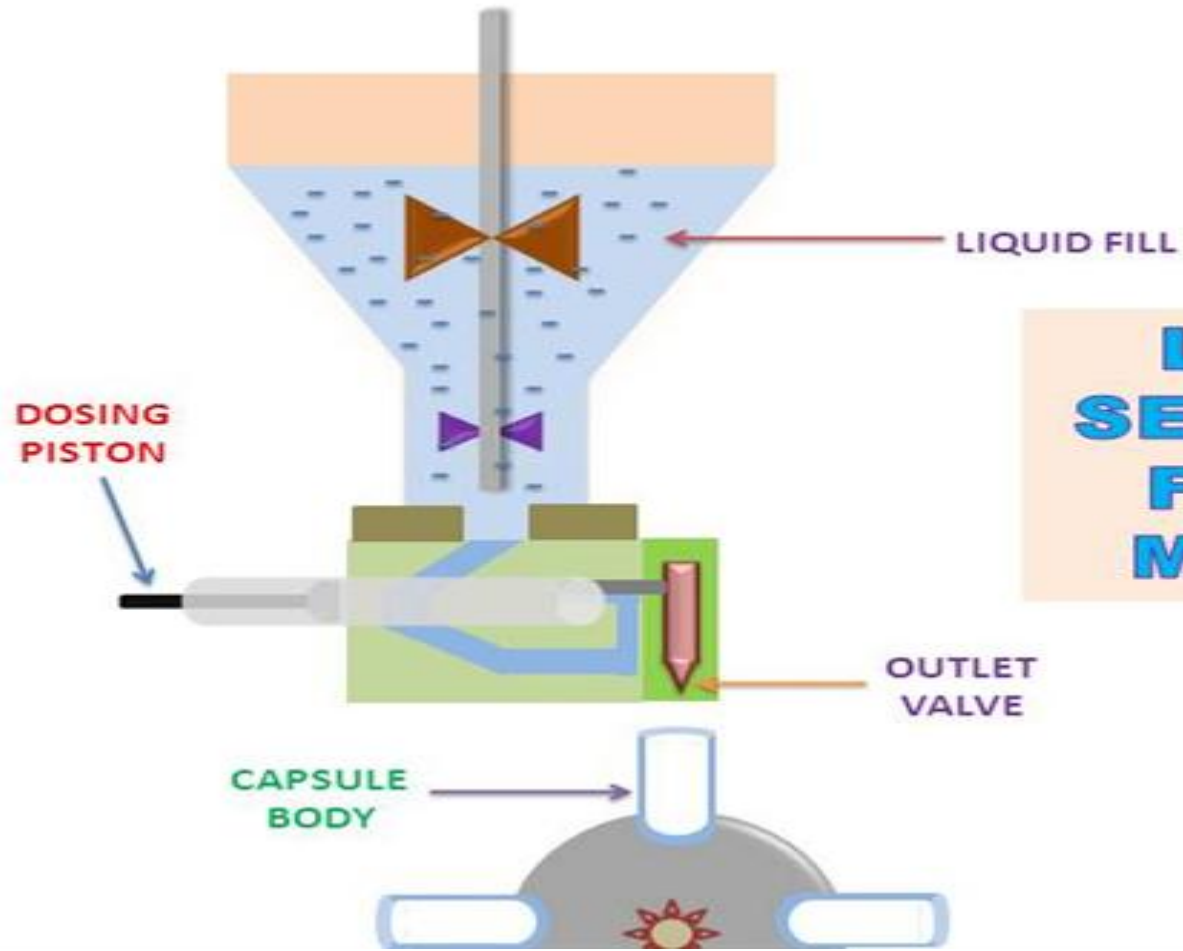

**LIQUID/  
SEMISOLID  
FILLING  
METHOD**

# COMPRESSION FILLING

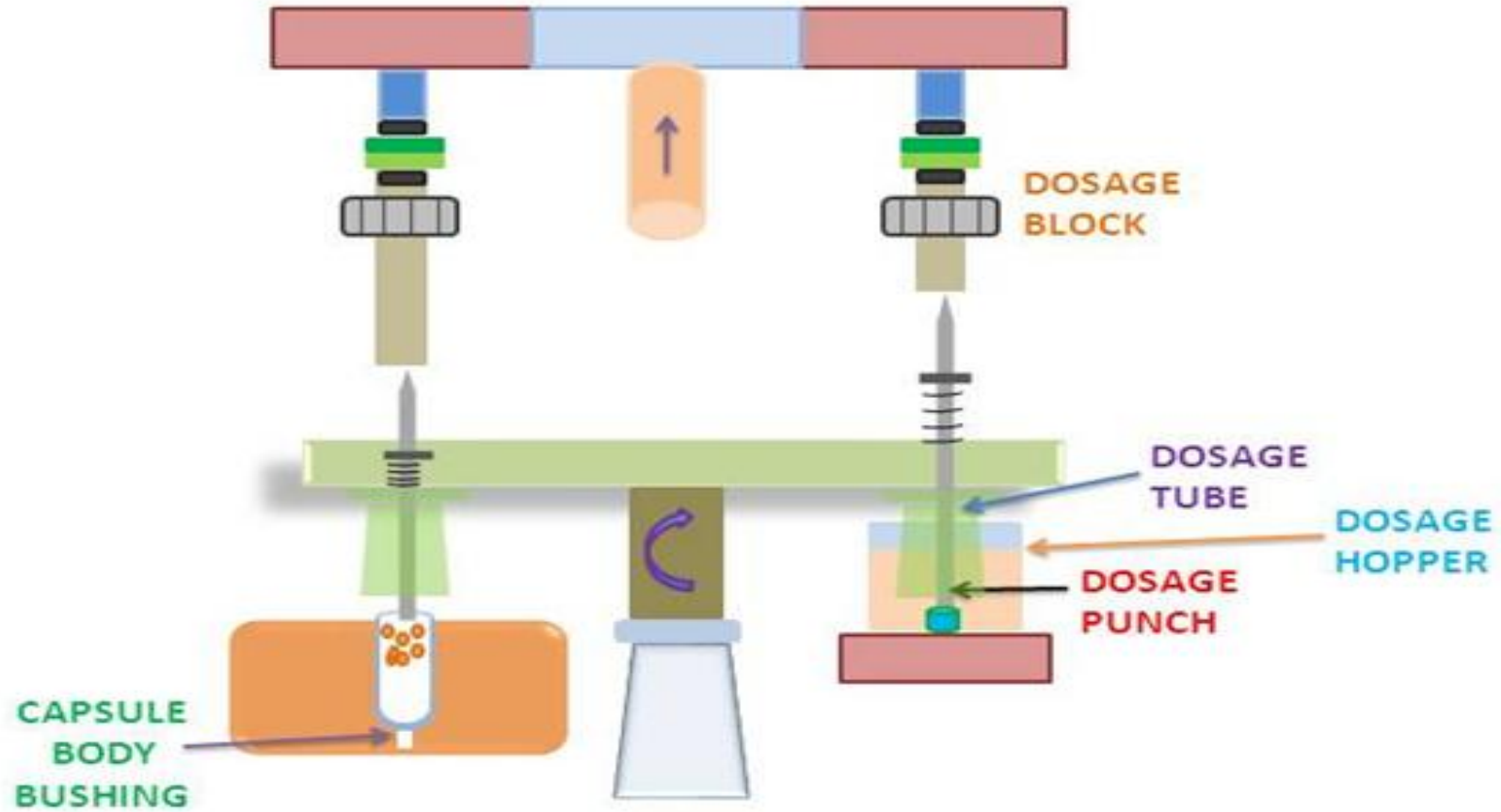

## VACCUM FILLING METHOD

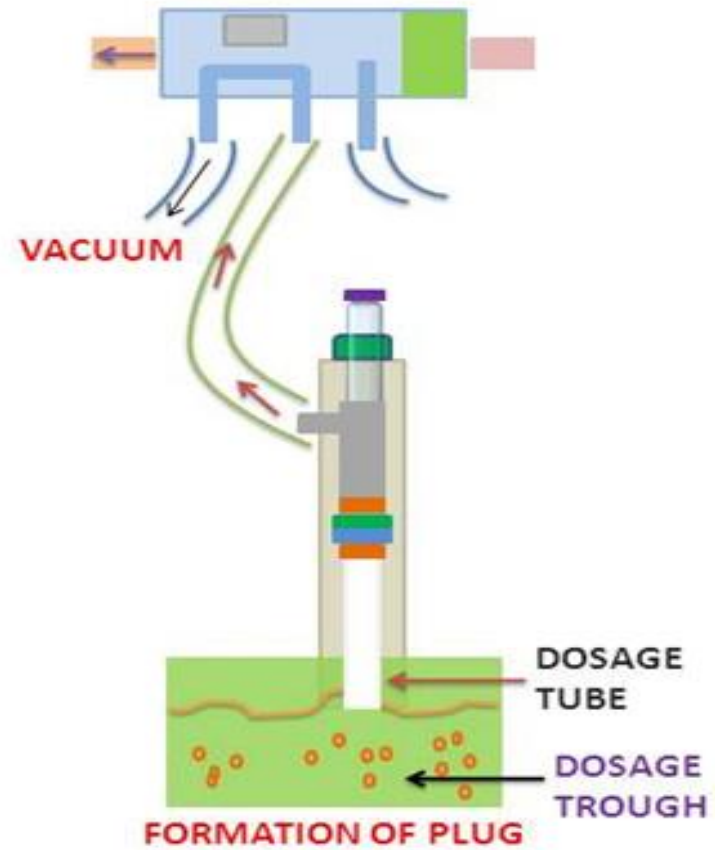



# SOFT GELATIN CAPSULE FILLING

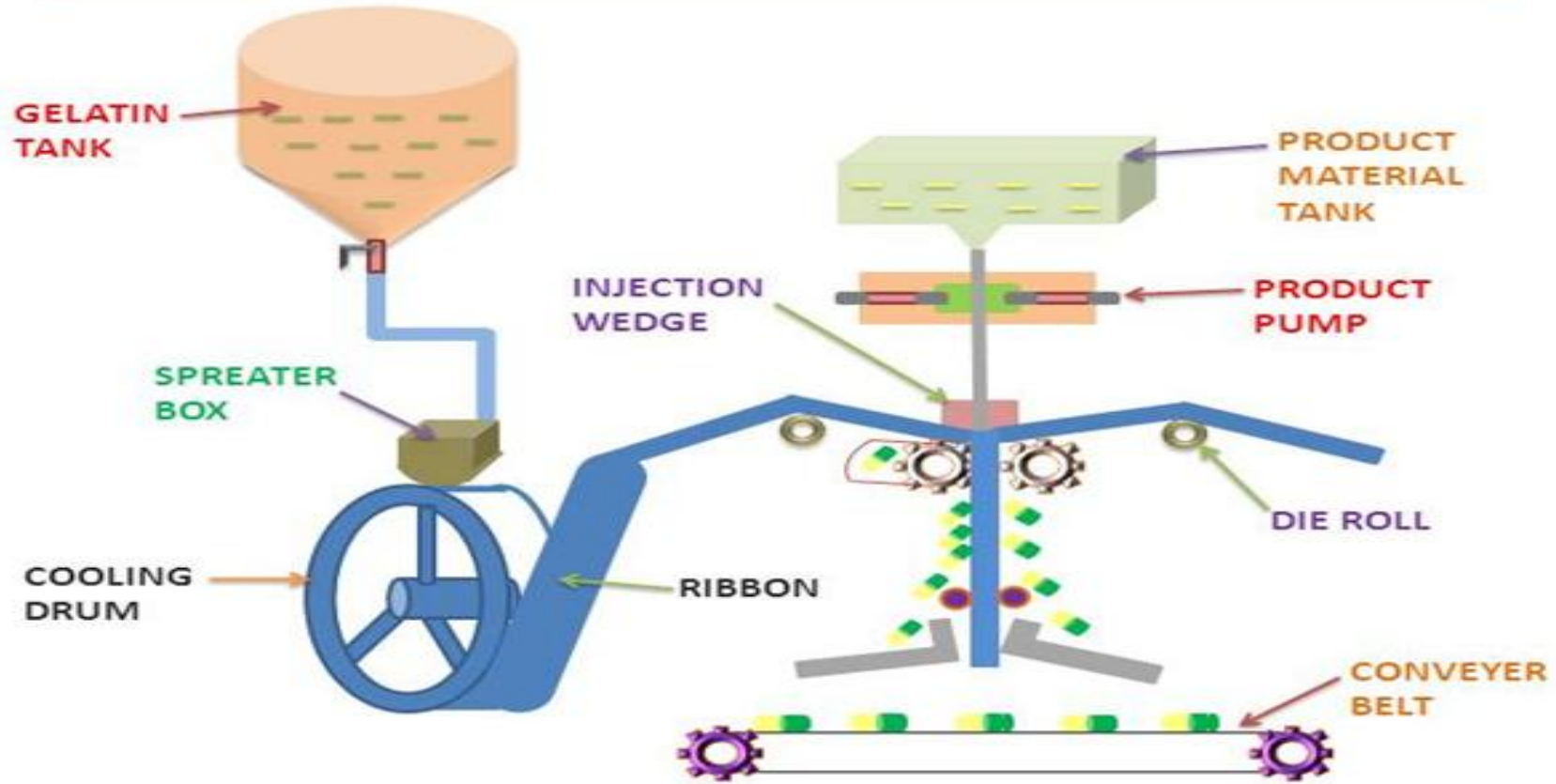



# DOSATER CAPSULE FILING MACHINE

| MACHINE SERIES : | PRODUCTION OUTPUT (CAPSULES PER HOUR) |
|------------------|---------------------------------------|
| Z25              | 25,000                                |
| Z40              | 40,000                                |
| Z180             | 180,000                               |

# TAMPING PIN CAPSULE FILLING MACHINES

| MACHINE SERIES | PRODUCTION OUTPUT (CAPSULES) |
|----------------|------------------------------|
| NJP -200       | 3,000 -8,500                 |
| NJP -1200      | 36,000 -72,000               |
| NJP – 3500     | 48,000 – 210,000             |

# CAPSULE SELECTION

## **□ CAPSULE SHELL PROVIDE:**

- The reason for the presence of each ingredient in the capsule formulae .**
- Justify the level and grade of each ingredient .**
- Explain the selection of the capsule size and shape**
- Discuss the need for capsule identification (color)**

# CAPSULE SELECTION...

- Establish the compatibility of the capsule shell and the capsule contents.
- Determine the hygroscopic nature of the capsule formulation.
- **For example** : A hygroscopic formulation (API/excipients) can pull from the capsule shell, which could effect the API stability.

## PROCESS EVALUATION AND SELECTION

- The process to manufacture the contents of a hard gelatin capsule is the same as the tablet.
- It may required only a blending step, such as a direct compression table, or several unit operations, such as a wet granulation tablet. (e.g. mixing, wet milling, drying, dry milling and blending)
- In either case, the materials are then encapsulated in a capsule shell'

# ENCAPSULATION

- The formulation should be encapsulated at a **wide range of speeds** to determine the operating range of the encapsulation.
- Encapsulation is a **critical step** in the production of capsules, similar to the compression for tablet dosage forms.
- The materials to be encapsulated will **need to have good flow properties** and a consistent **density**.

# QUALITY CONTROL TEST

## ☐ **PHYSICAL TEST :**

- **Disintegration test**
- **Dissolution test**

## ☐ **CHEMICAL TEST :**

- **Assay**
- **Content uniformity test**
- **Weight variation test**
- **Stability testing moisture permeation test**

# OPERATION CHECK FOR CAPSULE FILLING

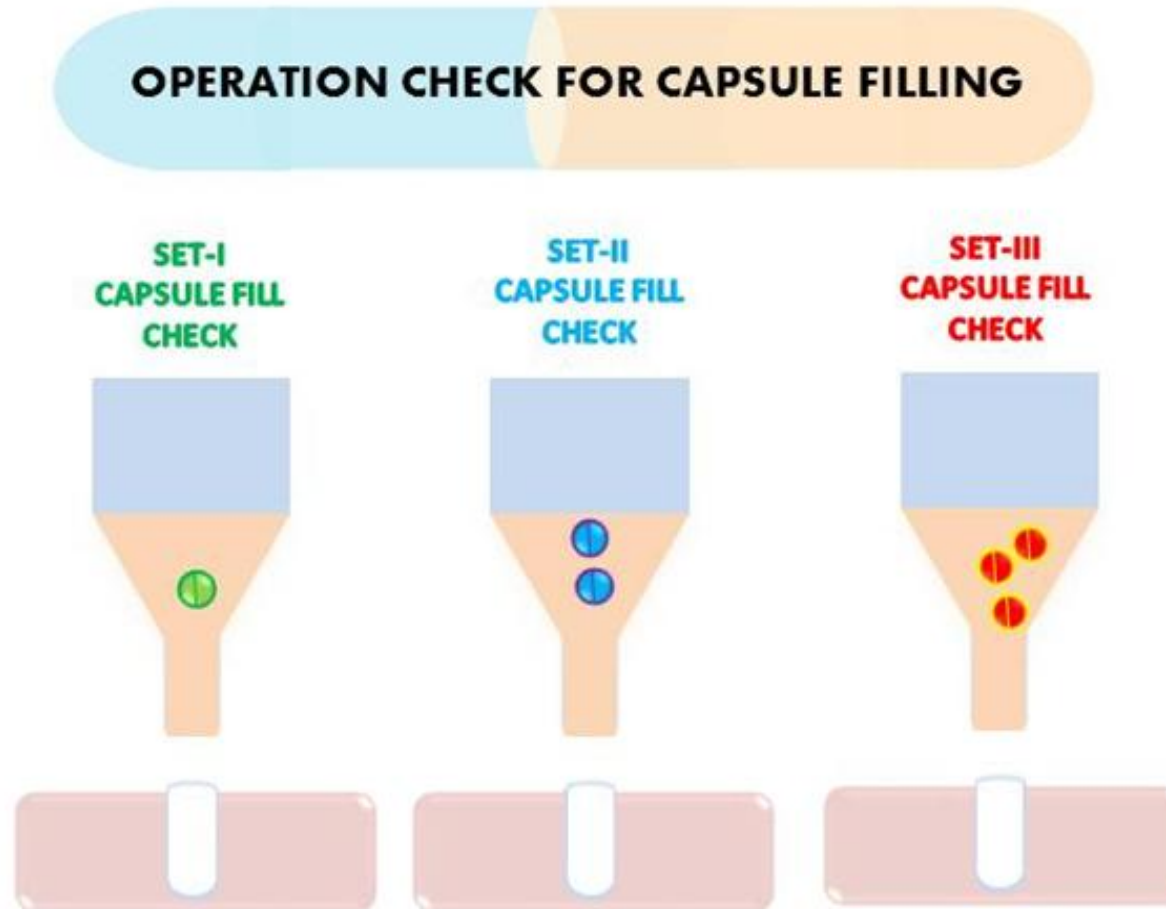



# QC OF HGC FILLING MACHINE

## ❖ VARIABLE :

- Machine speed, bed height compaction pressure, dosing volume, closing pressure .
- Speed die rotation, temperature of gelatin, ribbon thickness, temperature and humidity of processing area .

# QC FOR HGC

- Dose uniformity, weight variation, appearance /length, content uniformity, dissolution, microbial count, moisture content [brittleness]
- Elegance /color, capsule fill weight, capsule shell weight, capsule wall thickness assay and content uniformity, dissolution {where appropriate}, moisture content, leak test.

# USED REQUIREMENTS SPECIFICATION

- Basic document that is root for all validation and qualification.
- The goal of working out user requirement specifications is to document the needs of the manufacturing department.
- A well planned URS is the key to project success.

# USED REQUIREMENTS SPECIFICATION

- Project without detailed URS have a tendency to demand lots of change later on thus increase cost and start uptime .
- For evaluation of URS the coordinated approach among production, QA engineering units of the pharmaceutical company is required.

# REFERENCE

- Nash RA and Wachter AH, Pharmaceutical process validation, 3<sup>rd</sup> edition, Basel (NY) : Marcel Dekker Inc, 83- 110, 1993.
- Syed Imtiaz Haider, Pharmaceutical Master Validation Plan, St. Luice press, 114 , 119 , 120.
- Leon Lachman, The Theory and Practice of Industrial Pharmacy, Special Indian Edition, 374 – 412, 2009.
- <http://www.pharmainfo.net/reviews/guidelines-principles-validation-soild-dosage>.
- Mervyn J, Venketachallam VV, Hard gelation capsules - A formulation design perspective and evolution, International Journal of Chemical and Pharmaceutical Sciences, 5(3):129-135, 2014 .

# OINTMENT & CREAMS

# Contents

- Introduction
- What is ointment & creams
- Product testing
- Semisolid manufacturing consideration
- Unit operation for semisolid system

# Process validation

- Document evidence, a high degree of assurance that a specific process will consistently produce product that meets its predetermined specification and quality characteristics.



# Types of process validation

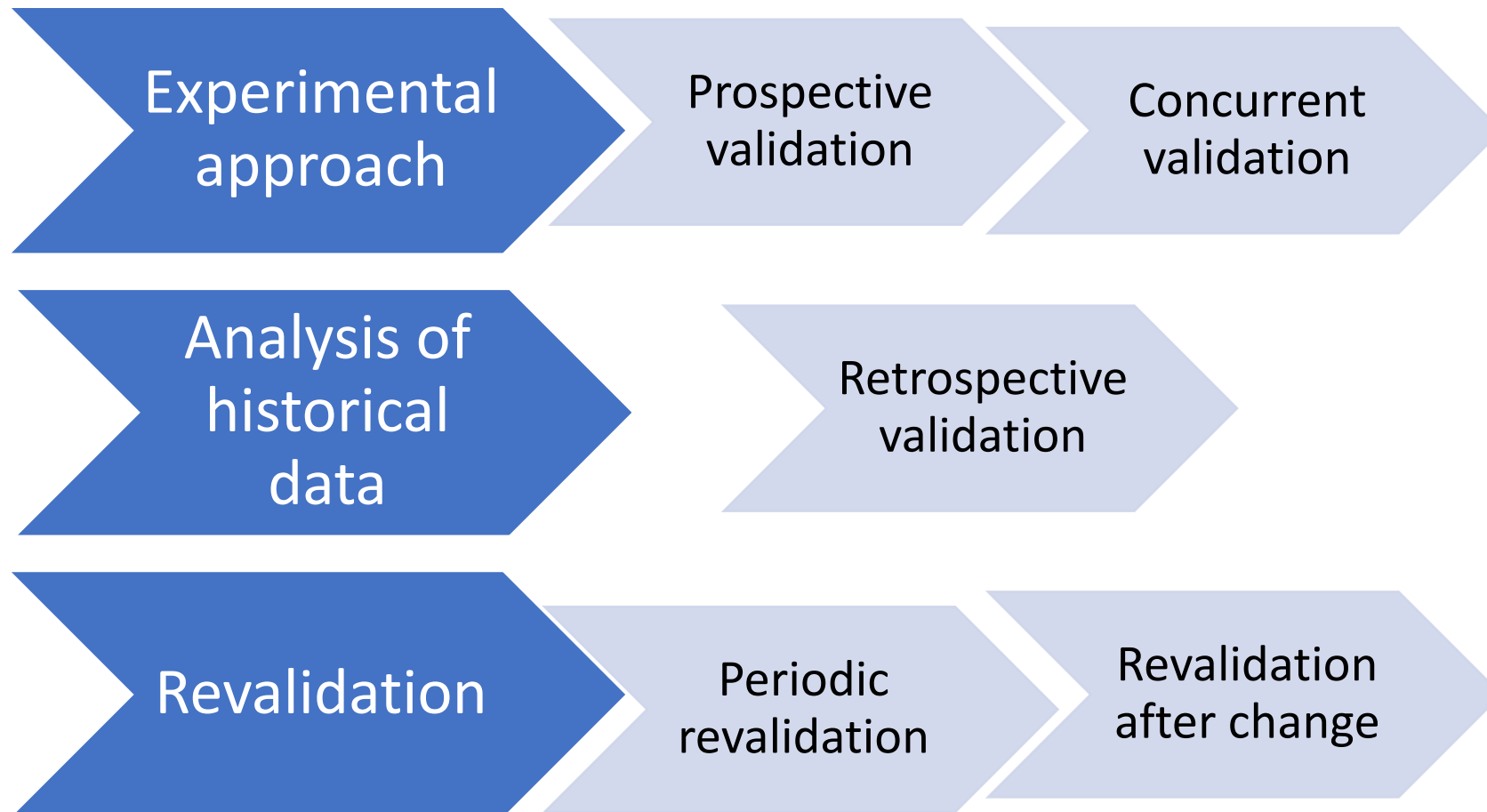

# Who dose process validation

- ✓ Formulation development
- ✓ Process development
- ✓ Pharmaceutical manufacturing
- ✓ QA
- ✓ QC
- ✓ Regulatory affairs

# Types of Documentation

- ❖ Validation Master plan (VMP)
- ❖ Validation protocols (VP)
- ❖ Validation reports (VR)
- ❖ Standard operating procedures (SOPs)

# Ointments

## ❖ Ointments:

Soft semisolid preparation intended for application to skin and mucus membrane.

Appearance : Opaque

# Types of Ointment bases

- Oleaginous bases
- Absorption bases
- Emulsion bases
- Water soluble bases

# Oleaginous Bases

- Oleaginous bases are also termed hydrocarbon bases.
- On application to the skin, they have an emollient effect, protect against the escape of moisture, are effective as occlusive dressing, can remain on the skin for long period without drying out and because of their immiscibility with water are difficult to wash off.
  - Examples of Hydrocarbon:  
White Petrolatum, White ointment and Yellow ointment.

# Absorption Bases

- Absorption bases are of two types,
  1. Those that permit the incorporation of aqueous solution resulting in the formation of water-in-oil emulsion.(e.g. hydrophilic petrolatum) .
  2. Those that are water-in-oil emulsion that permit the incorporation of additional quantities of aqueous solution .(e.g. lanolin).

# Water-Removable Bases

- ❖ Water-removable bases are oil-in-water emulsion resembling creams.
- ❖ Because the external phase of the emulsion is aqueous they are easily washed from skin and often called water-washable bases.



# Water-Soluble Bases

- ❑ Water-Soluble bases do not contain oleaginous components. They are completely water washable and often referred to as greaseless.

Example of water-soluble bases is polyethylene glycol ointment.

# CREAMS

❖ The viscous emulsion of semisolid consistency intended for application to skin and mucus membrane.

Appearance: Translucent

- Classification:

1. Oil-in-water(O/W)
2. Water-in-Oil(W/O)

# Processes must be validated in pharmaceutical manufacturing

- Cleaning
- Sanitation
- Fumigation
- Sterilization
- Sterile filling
- Fermentation
- Bulk production
- Purification, filling ,capping and sealing

# Sanitation

- The sanitation of clean areas is particularly important. Disinfectants are used more than one type should be employed.
- Disinfectants and detergents should be monitored for microbial contamination.

# Fumigation

- Fumigation is a method in which we use formaldehyde and potassium permanganate chemical in a pre defined ratio.
- By adding potassium permanganate in formaldehyde a reaction takes place and it generate fumes which effectively kill bacteria.
- Fumigation of clean areas may be useful for reducing microbial contamination in inaccessible places.

# Semisolid manufacturing consideration

- A. Flow diagram
- B. Unit operation for semi solid system
- C. Filling and packaging operation

# Flow chart of the process

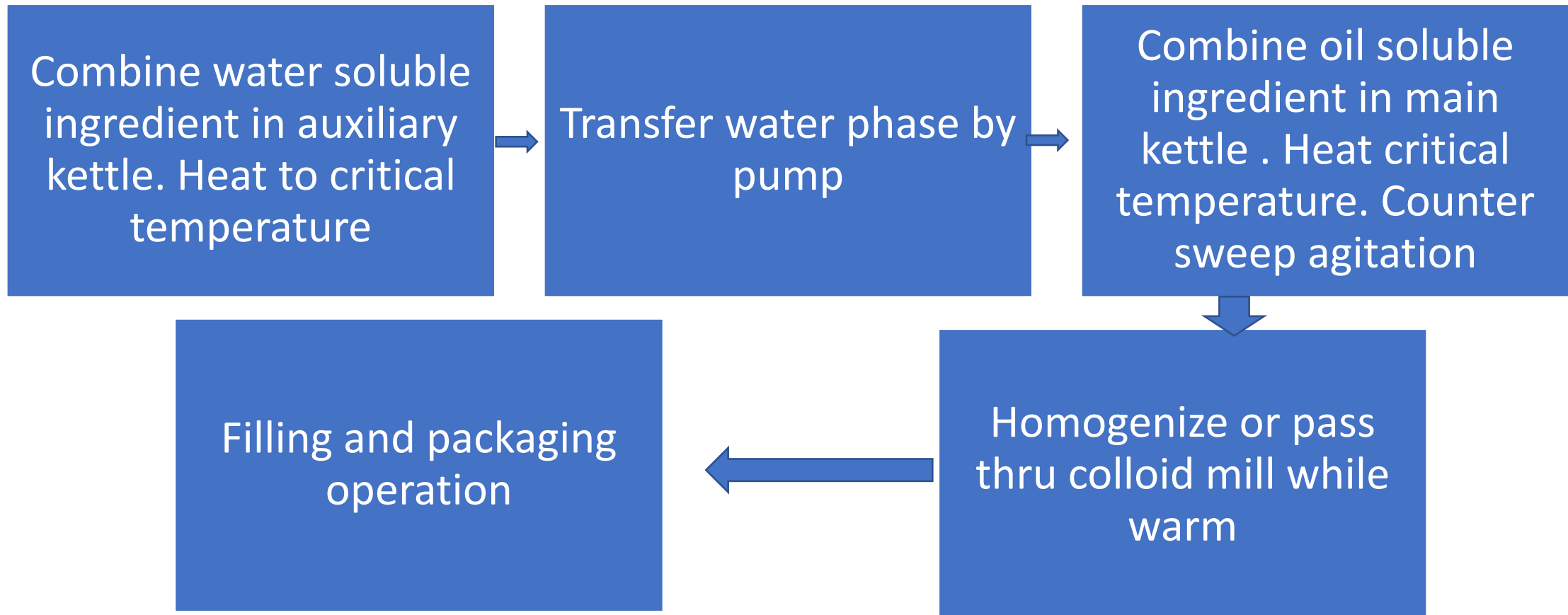

# Unit operation for semisolid system

## 1. Mixing of liquid:

Equipment: kettle and tank fitted with agitator.

## 2. Product Testing:

- Validation testing of bulk and finish product must be based on testing standard release criteria and in-process testing criteria.
- Validation sampling and testing typically is 3to6times the usual QC sampling



# Validation report

- ❖ Validation team must prepare the report.
- ❖ Report must be reviewed and approved by QA.
- ❖ Written notification or either successful completion or failure of the process validation must be issued to top management.
- ❖ In case of failure an investigation must be completed and documented prior to repeat the validation study.

# References

- Robert A. Nash and Alfred H. Wachter, *Pharmaceutical Process Validation*, 3<sup>rd</sup> Edition (Revised and Expanded), Marcel Dekker Inc., New York, 2003.
- Herbert A. Lieberman, Martin M. Reiger, and Gilbert S. Banker, *Pharmaceutical dosage forms: Disperse systems. Volume 2*, Marcel Dekker: New York. 1989.
- James P. Agalloco, Frederick J. Carleton, *Validation of Pharmaceutical Process*, 3<sup>rd</sup> edition, Informa Health Care, New York, 2008.
- *The theory and practice of industrial pharmacy*, 3<sup>rd</sup> ed. Edited by Leon Lachman, Herbert A. Lieberman and Joseph L. Kanig. Lea and Febiger, Philadelphia, 1986.

**LIQUID ORALS**

# What are oral liquids?

- ❖ Oral liquids are homogeneous liquid preparations, usually consisting of a solution, an emulsion or a suspension of one or more active ingredients in a vehicle.

# Liquid dosage forms can be administered

- Topically ( cream, foams, gels, lotions and ointments)
- Orally (per oral)
- Parenterally ( S.C,I.M,I.V)

# Classifications of liquid orals

- LIQUID ORALS

- Monophasic

- Solutions
- Linctuses
- Elixirs
- Syrups
- Liquid drops

# Classifications of liquid orals...

## ➤ BIPHASIC

- Suspension
- Emulsion

# Monophasic liquid

- ❖ Monophasic dosage form refers to liquid preparation containing two or more components in one phase system, it is represent by true solution.
- ❖ A true solution is a clear homogenous mixture that is prepared by dissolving solute in a suitable solvent.
- ❖ The component of the solution which is present in a large quantity is known as solvent where as the component present in small quantity is termed as solute.



# Biphasic liquid

- ❖ Biphasic dosage form contain two phases. This includes undissolved drug and the solvent system.
- ❖ Undissolved phase is distributed throughout a vehicle and intended for oral administration.
- ❖ In this preparation this phase is called '*Dispersed phase*' and the vehicle is called '*Dispersed medium*'.
- ❖ Its also called internal phase or external phase respectively.

# Liquid dosage forms can be prepared

- By dissolving the active drug substance in an aqueous or non-aqueous solvent e.g. alcohol, ether, glycerine.
- By suspending the drug in appropriate medium
- By incorporating the drug substance into an oil or water phases.

# Manufacturing of monophasic liquids

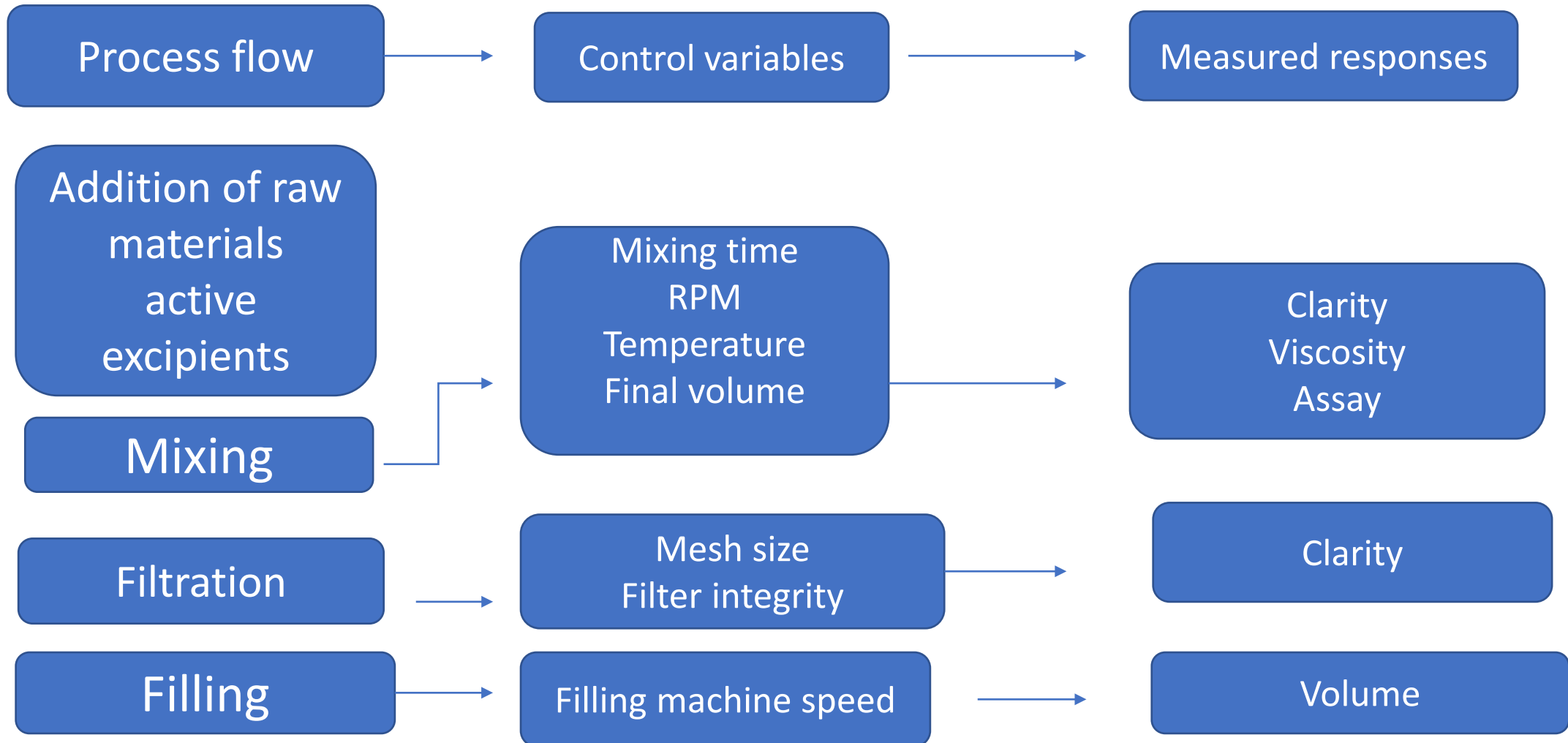

# Manufacturing of biphasic liquids

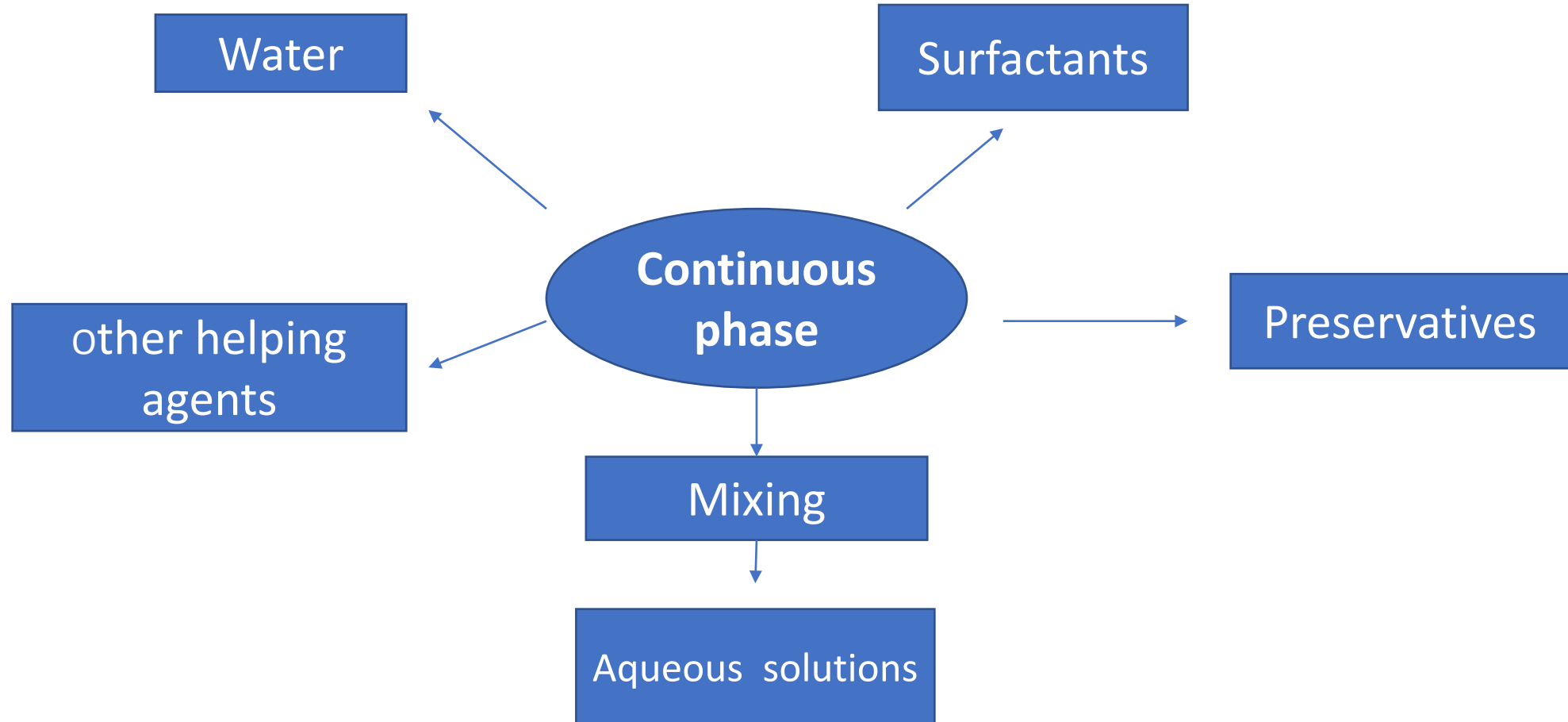

# Manufacturing of biphasic liquids...

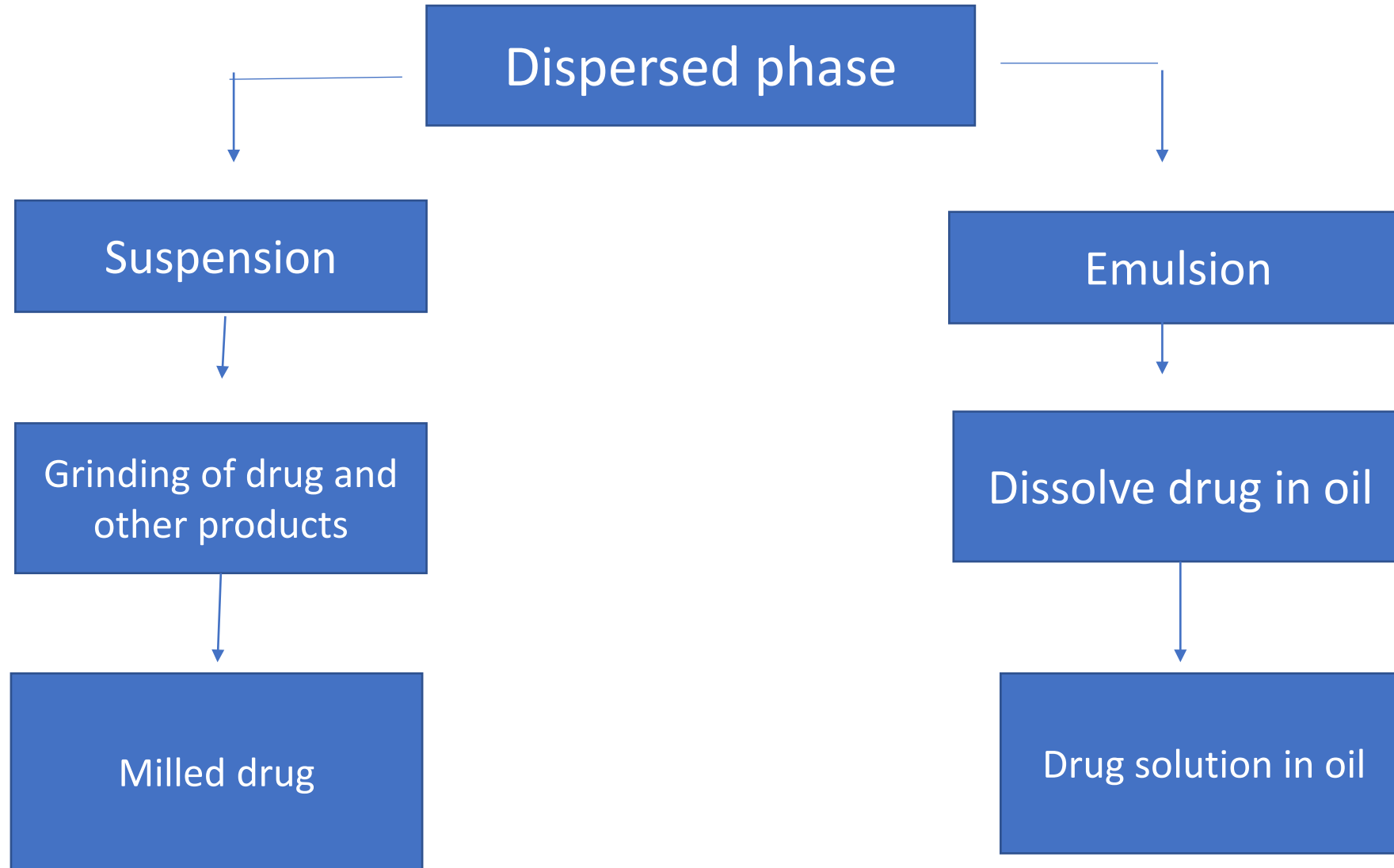

# Manufacturing of fine dispersed phase

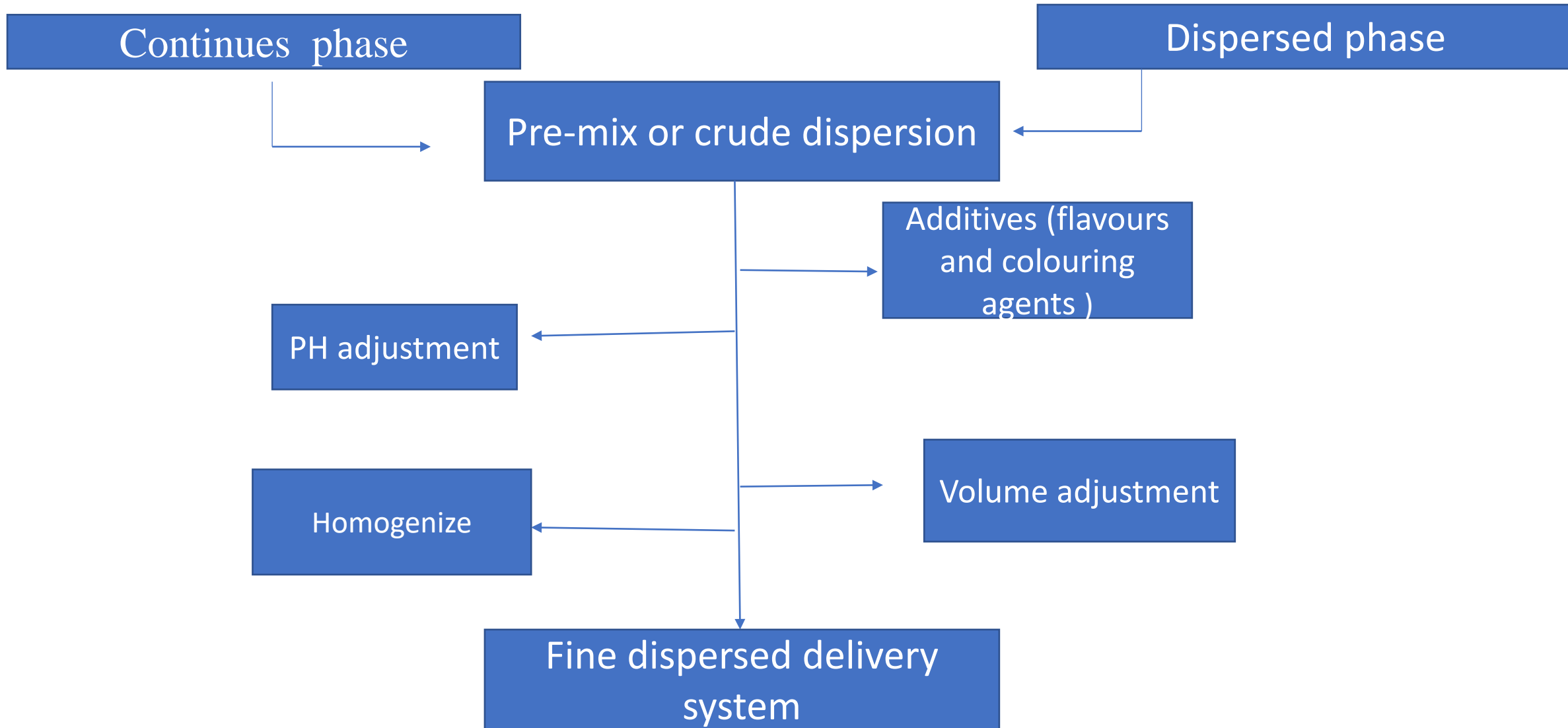

# Process validation concern to following operations

- Raw material validation
- Monitoring outputs
- Filling operations

# Raw material quality attributes

- Identity
- Safety
- Potency
- Purity
- Stability
- Efficacy



# Why validate ?

- ❖ It is required by the current good manufacturing practice (CGMP) regulations promulgated by the USFDA
- ❖ It should be performed because it is in accord with good business judgement

# Definition of raw material

- It is a term used to denote starting materials reagents and solvents intended for use in the production of intermediates or active pharmaceutical ingredients.

# Raw material validation

○ Several steps are required to validate a raw material they are as follows:

➤ LIST ALL THE RAW MATERIALS NEEDED PREPARE A PRODUCT BATCH :

- The list should include the materials used in production and testing
  - A. Active ingredients
  - B. Excipients
  - C. Processing aids
  - D. Chemicals
  - E. Official standards
  - F. laboratory materials

- Identify at least two suppliers for each raw material
  
- After we have complete list of all raw materials needed we must locate sources of these materials .
  
- It is always advisable to locate and validate at least two suppliers

## A. Evaluation for selecting a suppliers

- Provide the raw materials that we need
- Must be capable of providing the grade that we want
- Providing the quantity that we require
- To provide increased quantities quickly
- Determine whether our supplier is a manufacturer or distributor

## A. Evaluation for selecting a suppliers...

- ❑ Cost of the raw material
- ❑ Reputation and reliability of the supplier
- NOTE : He must use written standard operating procedures and establish proper raw material proper raw material storage and distribution procedures
  - Precautions
  - Joint agreements
  - attention
  - Investigation

## ➤ **If a supplier is new visit his facility**

- It is important to establish a good relationship with a supplier
- To meet representatives personally
- Inspect his facility

## ➤ If a supplier is new visit his facility...

- ❑ DURING THE VISIT IT IS ALSO IMPORTANT TO OBSERVE:
- ❑ Housekeeping and sanitation practiced
- ❑ Then use of written procedures and logs
- ❑ The use of laboratory notebooks
- ❑ The size of the laboratory area and staff
- ❑ The use up to date laboratory instrumentation and production equipment



# ➤ Obtain samples and suppliers certificates of analysis

- ❑ To determine the characteristics of the raw material
- ❑ The certificates of analysis and samples the extent of variation from lot to lot on specific tests
- ❑ It is important to measure this variation between different lots from the same supplier and then the variation between suppliers

# ➤ Establish specifications for each raw material

- ❑ List of parameters
- ❑ For each parameter listed , an acceptable ,measurable range of activity should be established
- ❑ Compendial raw materials
- ❑ And non compendial raw materials

## ➤ Establish test procedures

- ❑ A test procedure must be established for each specification
- ❑ For raw materials that are compendial ,test procedures are denoted along with their respective specifications
- ❑ For raw materials that are not listed in official compendia , we embark into methods development .
- ❑ This work calls on compendial methods that exist for similar compounds , which can be modified .

# ➤ Establish sampling procedures

- ❑ Documentation of raw material sampling is developed
- ❑ This procedure includes general requirements that may apply to any raw material received in the plant such as
  - The number of containers to sample
  - Method of sampling

# ➤ Establishing shelf life

- ❑ Shelf life or expiry dating of a raw material is the time period within which it must be used
- ❑ Some times we assign an expiry date that is shorter than our data indicate , so that we will always us fresh raw material
- ❑ The shelf life of a raw material is established by testing over time in the containers and closures to be used , after storage under the anticipated optimum conditions ,and also under adverse conditions .

## ➤ **Challenge of the raw materials**

- ❑ The last step required to validate a raw material is the operation in which the information that has been established concerning the raw material is challenged , to assure that is scientifically sound and meaningful.

# Monitoring outputs

- Appearance
- pH
- Viscosity
- Specific gravity
- Microbial count
- Content uniformity

# Monitoring outputs...

- ❖ **Appearance** of the final product indicates the signs of instability and degradation. For e.g. settling of solid particles in case of suspension and turbidity in case of emulsion.
- ❖ **pH** of aqueous oral formulations should be taken at a given temperature and only after equilibrium has been reached in order to minimize the pH drift.
- ❖ **Viscosity** affects the settling rate of suspended particles in suspension and coalescence of globules of internal phase in emulsion and also in case of oral solutions it affects the overall appearance of the final [product so it must be measured and validated.
- ❖ **Specific gravity**- A decrease in specific gravity of the product like suspension indicates the presence of air within the structure of the formulation.



# Monitoring outputs...

- ❖ **Microbial count** for the final product is essential to validate because by performing microbial count we can select the preservative for the final product storage. There are specifications for each liquid oral product for the bio burden content.
- ❖ **Content uniformity** affects the dose uniformity in case of multi dose formulations and also affects the homogeneity of the drug within solvent system.

# Filling operation

- Leakage test for filled bottle
- Cap sealing test
- Water vapour permeability test

## Leakage test

- Fill ten containers with water , fit with closures and keep them inverted at room temperature for 24 hours. There are no signs of leakage from any container .

# Water vapour permeability

- Fill five containers with the water and heat –seal the bottles.
- Weigh accurately each container and allow to stand for **14 days** at a relative humidity of **60+( or )-5 %** and a temperature between **20degree and 25 degree**
- Reweigh the containers.
- The loss in weight in each container is not more than 0.2% .

# Cap sealing machine

- **Cap sealing machine** : is used for sealing the cap of plastic containers and plastic bottles . The machines work while being placed in a table at a fixed height and the bottle moves up and down via the use of a table and thus ,sealing is done .

# Cap sealing machine key features

- Easy location of plastic container underneath the heating pad
- Thermostat to adjust according to the thickness of plastic cap or foil
- Well known for its user friendly design
- Less maintenance and reliable operation
- Long endurance
- Reliable to great extent
- Rugged construction
- Lasts pretty long

# Cap sealing machine useful for

- Sweet packing
- Juice, sharbat, mineral water, milk, lassi, curd, pesticides, etc

# Cap sealing machine suitable for

- Plastic containers , plastic cup , plastic bottles.
- Pack with aluminium foil or plastic cap.
- Available size :150mm (6'').200mm(8'')



# Reference

1. Manish K, Potdar MA, Inamdar RI, Chougule DD, Mahale KB, Process validation and data representation by retrospective approach for manufacturing process of multivitamin liquid oral syrup preparation in an industrial setup, *Inventi Impact: Pharm Ana & Qual Assur.*, 3: 103-111, 2011.
2. Guidelines on general principles of process validation, CDER, USFDA, 1987.
3. Sharma PP, *How to practice GMP*, 7<sup>th</sup> edition, 1991.
4. Robert A.Nash and Alfred H.Wachter, *Pharmaceutical Process Validation*, 3<sup>rd</sup> Edition (Revised and Expanded), Marcel Dekker Inc., New York, 2003.
5. *Validation of compendia methods*, USP convention, 1995.

*Thank you*